



**JCM**  
movelaria

# Rack Humor Humor TV Stand Mesa de TV Humor









Indicamos que a montagem dos produtos seja realizada com parafusadeira eléctrica e por um montador profissional.  
**We recommend that a professional furniture assembler assemble the product by using a cordless screwdriver.**  
*Se recomienda que un montador de muebles profesional realice el montaje del producto con un destornillador eléctrico.*

AVISO: Não nos comprometemos pelo mal-uso, montagem e fixação do produto à parede. Portanto, não somos responsáveis por danos e quedas do produto, eletrônicos e pertences neles contidos. É importante o uso de brocas e ferramentas compatíveis na montagem.  
**NOTICE:** The company is not responsible for the misuse, assembly, and wall fixation, as well as the damages and falls that the products, electronics, and belongings therein might suffer. It is important to use suitable drills and tools to assemble the product.  
*ATENCIÓN: La empresa no se responsabiliza del mal uso, montaje y fijación del producto a la pared, así como de daños y caídas del producto, electrónicos u objetos. Es importante el uso de taladros y herramientas compatibles con el montaje.*

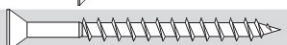







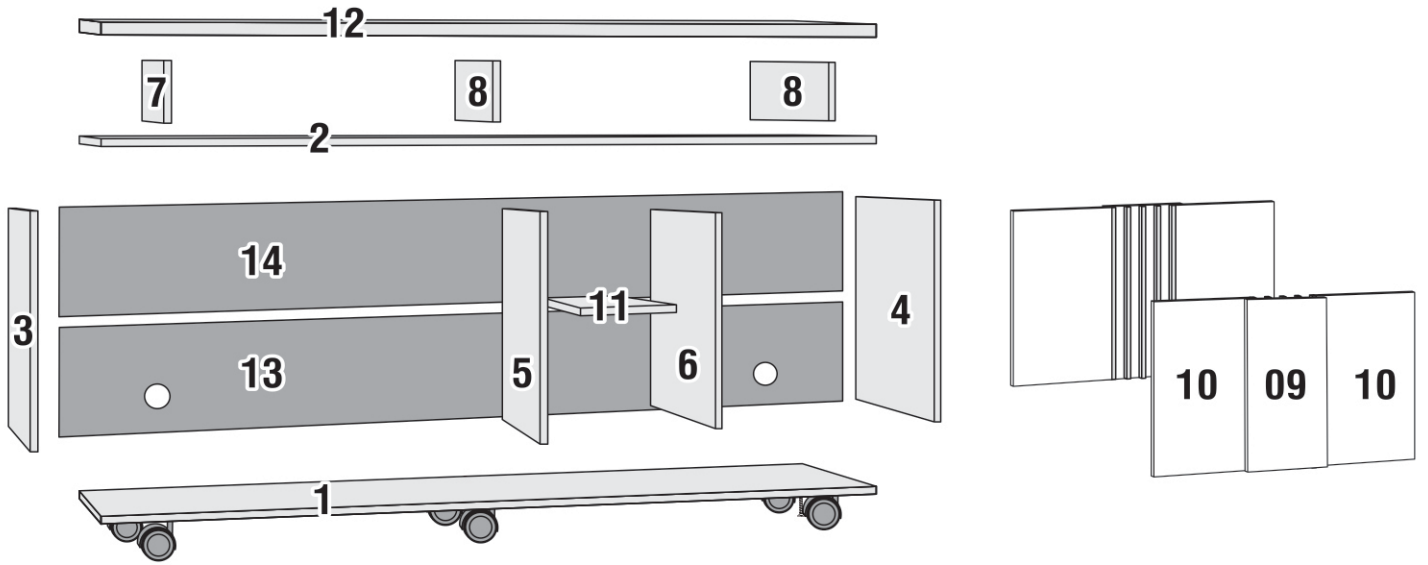





Dica: para evitar possíveis avarias, use a embalagem do produto como apoio durante a montagem.  
**Tip: to avoid damages, use the product packaging as a base during the assembly.**  
*Pista: para evitar daños, use el envase del producto como apoyo durante el montaje.*

## RELAÇÃO DE FERRAGENS | HARDWARE LIST | LISTADO DE HERRAJES

KIT ROLDANA	(A)	ROLLER KIT	(A)	KIT RODILLO	(A)		01
PARAFUSO CHP CHA BC 3,5x14	(B)	3.5x14 SCREW	(B)	TORNILLO 3,5x14	(B)		32
PARAFUSO CHP CHA BC 4x25	(C)	4x25 SCREW	(C)	TORNILLO 4x25	(C)		16
PARAFUSO ESTR CHA PHI ZP 5x40	(D)	5x40 SCREW	(D)	TORNILLO 5x40	(D)		14
PARAFUSO MINIFIX	(E)	MINIFIX BOLT	(E)	PERNO MINIFIX	(E)		14
PINO PRATELEIRA	(F)	SHELF SUPPORT	(F)	SOPORTE DE ESTANTE	(F)		04
PREGO 8x8 C/C	(G)	8x8 NAIL	(G)	CLAVO 8x8	(G)		30
TAMBOR MINIFIX 12x10mm	(H)	12x10mm MINIFIX CAM	(H)	CAJA MINIFIX 12x10mm	(H)		14
RODÍZIO	(I)	CASTER	(I)	RUEDA	(I)		06

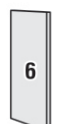
RELAÇÃO DE PEÇAS | PARTS LIST | LISTADO DE PARTES



 <p><b>1</b> Base Bottom Fondo 1Pc</p>	 <p><b>8</b> Divisão Superior Central/Direita Middle Right Upper Division División Superior Central Derecha 2Pcs</p>
 <p><b>2</b> Tampo Intermediário TV Stand Top Tapa Mesa de TV 1Pc</p>	 <p><b>09</b> Fundo Porta Door Back Trasera de la Puerta 1Pc</p>
 <p><b>3</b> Lateral Esquerda Left Side Lateral Izquierdo 1Pc</p>	 <p><b>10</b> Paine Porta Door Panel Panel de la Puerta 2Pcs</p>
 <p><b>4</b> Lateral Direita Right Side Lateral Derecho 1Pc</p>	 <p><b>11</b> Prateleira Small Shelf Estante Pequeño 1Pc</p>
 <p><b>5</b> Divisão Inferior Esquerda Lower Left Division División Inferior Izquierdo 1Pc</p>	 <p><b>12</b> Tampo Superior Top Shelf Estante Superior 1Pc</p>
 <p><b>6</b> Divisão Inferior Direita Lower Right Division División Inferior Derecho 1Pc</p>	 <p><b>13</b> Costas Inferior Lower Back Trasera Inferior 1Pc</p>
 <p><b>7</b> Divisão Superior Esquerda Upper Left Division División Superior Izquierda 1Pc</p>	 <p><b>14</b> Costas Superior Upper Back Trasera Superior 1Pc</p>

Passo 01 INICIE A MONTAGEM PELA PEÇA 12. ENCAIXE E APERTE AS PEÇAS 7 E 8 NA PEÇA 12 COM MINIFIX (E+H).

Step 01 START THE ASSEMBLY BY PART 12. FASTEN PARTS 7 AND 8 TO PART 12 WITH MINIFIX (E+H).

Paso 01 EMPIECE EL MONTAJE POR LA PARTE 12. FIJE LAS PARTES 7 Y 8 A LA PARTE 12 WITH MINIFIX (E+H).

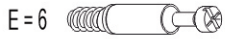
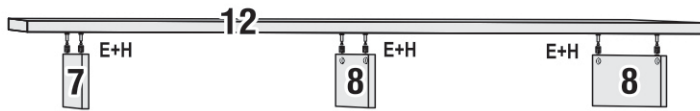

VISTA FRONTAL  
FRONT VIEW  
VISTA FRONTAL

Passo 02 PARAFUSE A PEÇA 2 NAS PEÇAS 7 E 8 COM PARAFUSO 5x40 (D).

Step 02 FASTEN PART 2 TO PARTS 7 AND 8 WITH 5x40 SCREW (D).

Paso 02 FIJE LA PARTE 2 A LAS PARTES 7 Y 8 CON TORNILLO 5x40 (D).

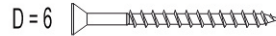
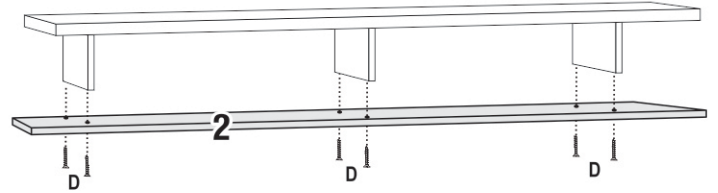

VISTA FRONTAL  
FRONT VIEW  
VISTA FRONTAL

Passo 03 ENCAIXE E APERTE AS PEÇAS 3, 5, 6 E 4 NA PEÇA 2 COM MINIFIX (E+H).

Step 03 FASTEN PARTS 3, 5, 6, AND 4 TO PART 2 WITH MINIFIX (E+H).

Paso 03 FIJE LAS PARTES 3, 5, 6 Y 4 A LA PARTE 2 CON MINIFIX (E+H).

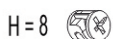
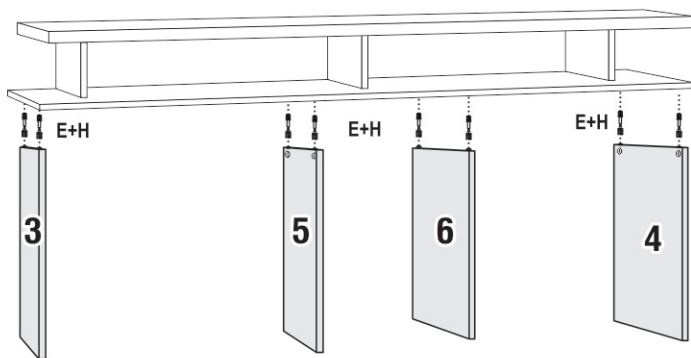

VISTA FRONTAL  
FRONT VIEW  
VISTA FRONTAL

Passo 04 PARAFUSE A PEÇA 1 NAS PEÇAS 3, 5, 6 E 4 COM PARAFUSO 5x40 (D).

Step 04 FASTEN PART 1 TO PARTS 3, 5, 6, AND 4 WITH 5x40 SCREW (D).

Paso 04 FIJE LA PARTE 1 A LAS PARTES 3, 5, 6 Y 4 CON TORNILLO 5x40 (D).

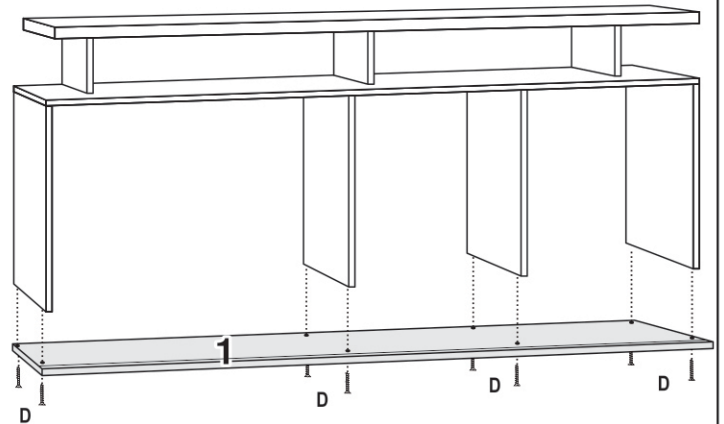

VISTA FRONTAL  
FRONT VIEW  
VISTA FRONTAL

Passo 05 PARAFUSE OS RODÍZIOS (I) COM PARAFUSO 3,5x14 (B).

Step 05 FASTEN THE CASTERS (I) WITH 3.5x14 SCREW (B).

Paso 05 FIJE LAS RUEDAS (I) CON TORNILLO 3,5x14 (B).

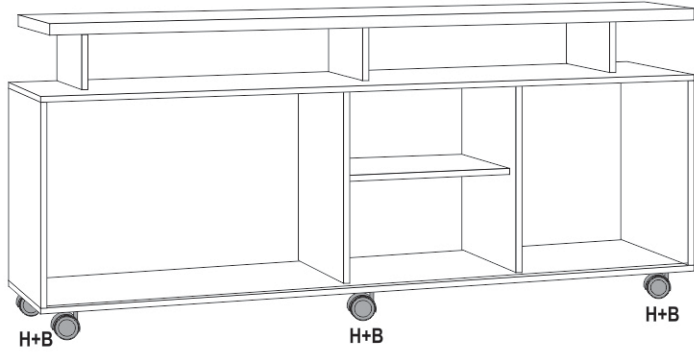

B = 24 

I = 6 

VISTA FRONTAL  
FRONT VIEW  
VISTA FRONTAL

Passo 06 PREGUE AS COSTAS COM PREGO 8x8 (G).

Step 06 FASTEN THE BACK WITH 8x8 NAILS (G).

Paso 06 FIJE LA TRASERA CON CLAVOS 8x8 (G).

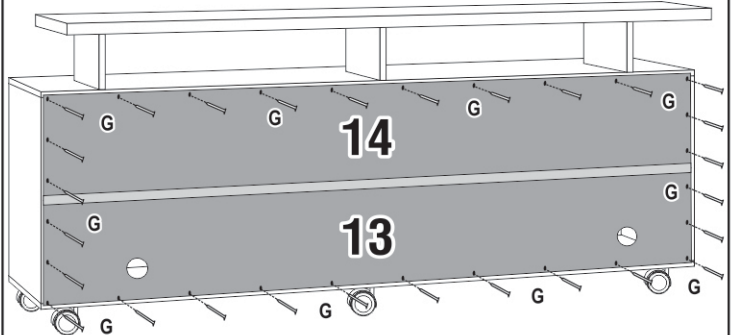

G = 30 

VISTA TRASEIRA  
BACK VIEW  
VISTA TRASERA

Passo 07 MONTE A PORTA PARAFUSANDO AS PEÇAS 9, 10 E 15 CONFORME DESENHO ABAIXO, USANDO AS RESPECTIVAS FERRAGENS.

Step 07 ASSEMBLE THE DOOR BY FASTENING PARTS 9, 10, AND 15 WITH THEIR HARDWARE, AS THE PICTURE SHOWS.

Paso 07 MONTE LA PUERTA FIJANDO LAS PARTES 9, 10 Y 15 CON SUS HERRAJES, SEGÚN EL DISEÑO.

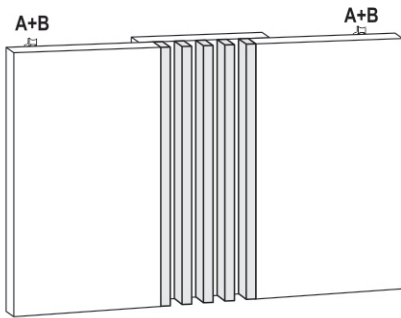

VISTA FRONTAL  
FRONT VIEW  
VISTA FRONTAL

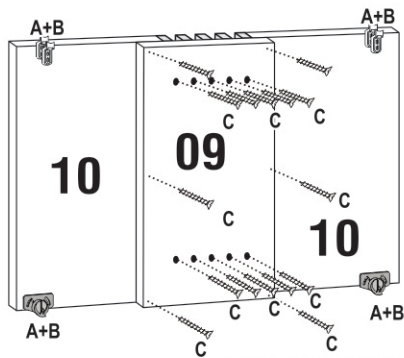

A = 1 

B = 8 

C = 16 

VISTA TRASEIRA  
BACK VIEW  
VISTA TRASERA

Passo 08 COLOCAR A PEÇA 11 COM PINO PRATELEIRA (F).

Step 08 FASTEN PART 11 WITH SHELF SUPPORT (F).

Paso 08 FIJE LA PARTE 11 CON SOPORTE DE ESTANTE (F).

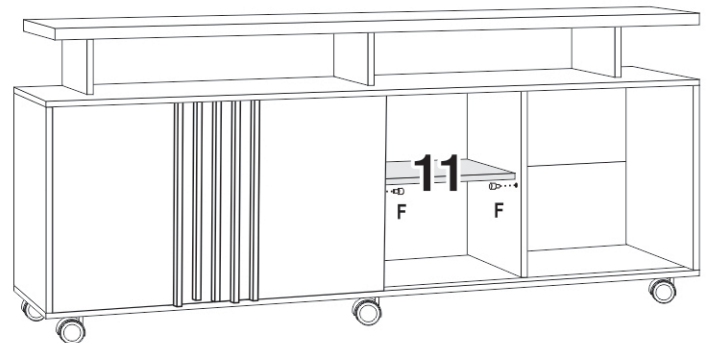

F = 4 

VISTA FRONTAL  
FRONT VIEW  
VISTA FRONTAL