

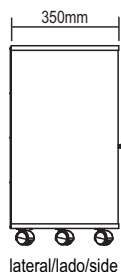

Rack Sampa

Rack Sampa / Sampa Rack

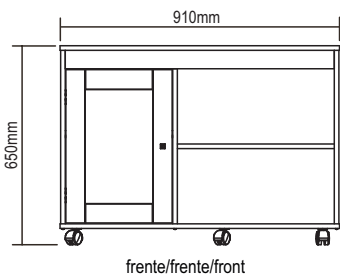
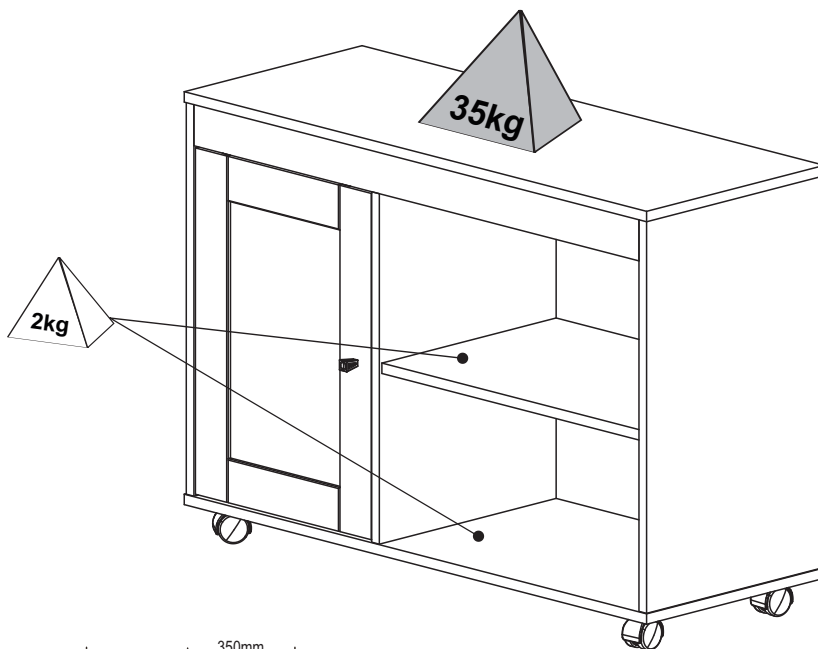

Assista ao vídeo de montagem
Asista al video de montaje
Watch the assembly video

Conservação e Limpeza - Conservación y Limpieza - Conservation and Cleaning

Não expor o produto ao sol, altas temperaturas e umidade. Não arrastar objetos sobre a superfície do móvel (ex.: TV, equipamentos eletrônicos, objetos decorativos...). Manter em local seco e arejado. Para a limpeza, utilizar um pano seco e macio. Não é necessário o uso de materiais abrasivos ou álcool.

No exponga el producto a la luz solar, las altas temperaturas y la humedad. No arrastre los objetos en la superficie de la unidad (por ejemplo, TV, equipos electrónicos, objetos de decoración ...). Mantener en un lugar fresco y seco. Para la limpieza, utilizar un paño seco y suave. El uso de materiales abrasivos o del alcohol no es necesario.

Do not expose the product to sunlight, high temperatures and humidity. Do not drag objects across the surface of the unit (TV, electronic equipments, decorative objects ...). Keep it in a cool and dry place. For cleaning, use a dry and soft cloth. Do not use abrasive materials or alcohol.

Garantia

Este certificado de Garantia é uma vantagem adicional oferecida ao consumidor, porém para que o mesmo tenha validade é imprescindível que seja apresentada a NOTA FISCAL de compra do produto.

Com este produto, a **Artely** tem como objetivo atender plenamente o proprietário-consumidor, proporcionando a garantia na forma aqui estabelecida, pelo período de três meses a partir da data da nota fiscal de compra. A **Artely** restringe a sua responsabilidade à substituição gratuita das peças defeituosas, em caso de defeitos ou avarias devidamente constatados como sendo de fabricação, durante a vigência desta garantia.

A **Artely** declara a garantia nula e sem efeito se o produto for alterado, adulterado, molhado ou consertado e ainda pela prática de montagem inadequada ou mau uso. Também será considerada nula em casos de força maior, como aqueles causados por agentes da Natureza (chuvas, incêndios, excesso de umidade, cupins,...) e eventos externos como objetos arrastados sobre a superfície do móvel (ex.: TV, DVD, aparelho de som, objetos decorativos...).

Para exercer seus direitos de comprador é importante que antes de montar seu produto você leia com atenção as instruções de cada passo do manual de montagem que acompanha o móvel.

Caso o produto não esteja em conformidade, entre em contato com a loja onde efetuou a compra e faça sua reclamação, apontando os defeitos técnicos observados. Para agilizar o seu atendimento, tenha sempre em mãos o manual de montagem com os respectivos números das peças defeituosas, conforme descritas no manual.

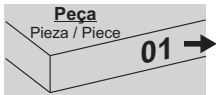

- O número na borda da peça corresponde ao manual.
- Para retirada do número usar Lustra-Móveis, Alcool em Gel ou Borracha.
- El número en el borde de la pieza coincide con el manual.
- Use una goma de borrar blanca, alcohol en gel o lustrador para muebles para eliminar los números.
- The number on the edge of the piece matches the manual.
- Use a White eraser, Alcohol Gel or Furniture Polish to remove the numbers.

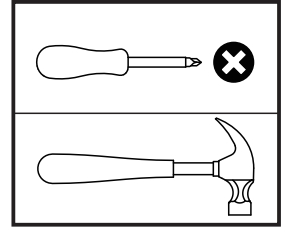



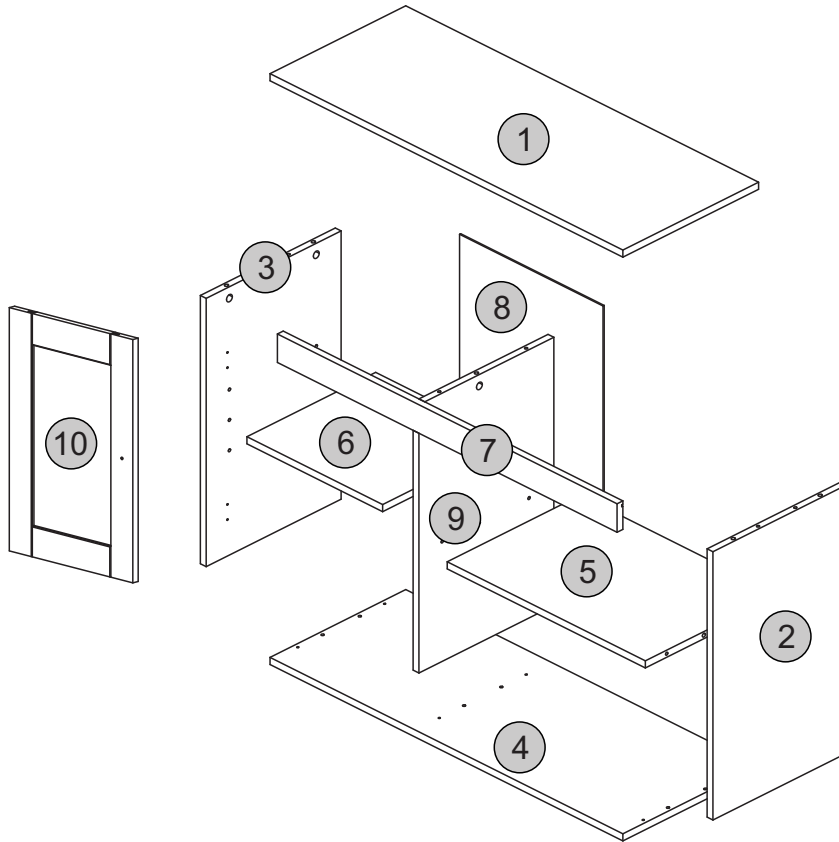





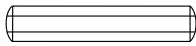

Ferramentas não fornecidas

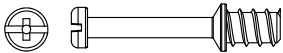

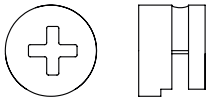
Descrição	Description	Descripción	Qty
1-Tampo (910x350x15mm)	1-Top	1-Tapa	1
2-Lateral Direita (565x348x15mm)	2-Right side	2-Lado derecho	1
3-Lateral Esquerda (565x348x15mm)	3-Left side	3-Lado izquierdo	1
4-Base (910x350x15mm)	4-Base	4-Base	1
5-Prateleira Maior (511x343x15mm)	5-Large Shelf	5-Estante Grande	1
6-Prateleira Móvel (350x332x15mm)	6-Small Shelf	6-Estante pequeña	1
7-Travessa (876x60x15mm)	7-Platter	7-Travesaño	1
8-Traseiro (590x370x3mm)	8-Rear	8-Trasero	1
9-Divisão (565x348x15mm)	9-Division	9-División	1
10-Porta (499x346x15mm)	10-Door	10-Puerta	1

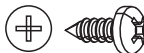
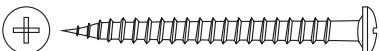
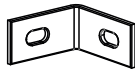
Lista de Materiais

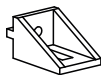
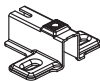
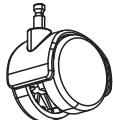
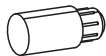
Lista de Materiales/ Hardware List

A		Cavilha / Tarugo / Dowel Ø6x30mm Madeira	16	J		Puxador / Arrancador / Puller	01
B		Minifix / Minifix / Minifix Ø7x30mm Metal	07	K		Prego / Clavo / Nail 8x8 Metal	14
C		Tambor / Tambor / Minifix Cam Ø15x12mm Metal	07	L		Parafuso / Tornillo / Screw / Ø3,5x25mm CP Metal - Cabeça Philips	01
D		Tapa furo adesivo / Adesivo / Hole Cover Ø18mm Papel	05	M		Parafuso Ø4,0x14mm CC Metal - Cabeça Philips	18
E		Parafuso / Tornillo / Screw / Ø3,5x40mm CP Metal - Cabeça Philips	06	N		Cantoneira / Esquina / Corner	02
F		Dobradiça / Bisagra / Hinge / Metal - 26mm	02	O		Suporte Angular Soporte angular Angular Support	03
G		Calço / Cuña / Chock /	02	P		Rodizio Rotación Rotation	05
H		Pino / Alfiler / Pin Ø6x18	04	Q		Bucha / Cojinete / Bushing	05
				R		Produto Moldado / Silicona / Silicone 8mm	01

DICAS PARA FIXAR MINIFIX

TIP TO FASTEN THE MINIFIX
PISTA PARA ARREGLAR EL MINIFIX

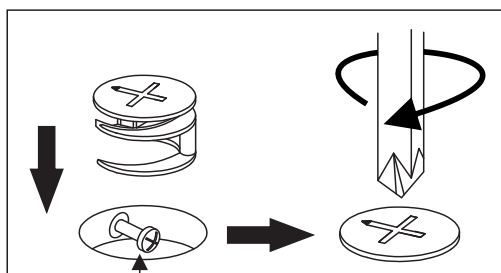

Cabeça do parafuso precisa estar no centro

La cabeza del tornillo debe estar en el centro
Screw head has to be in the center

Parafuso Minifix

Tornillo minifix/Minifix screw

Fixe o parafuso até o ressalto encostar na superfície da peça (veja o exemplo abaixo).

Tighten the screw until its overhang part lean on the piece surface (see the example below).

Fije el tornillo hasta que su parte sobresaliente toque la superficie de la pieza (vea el ejemplo abajo).

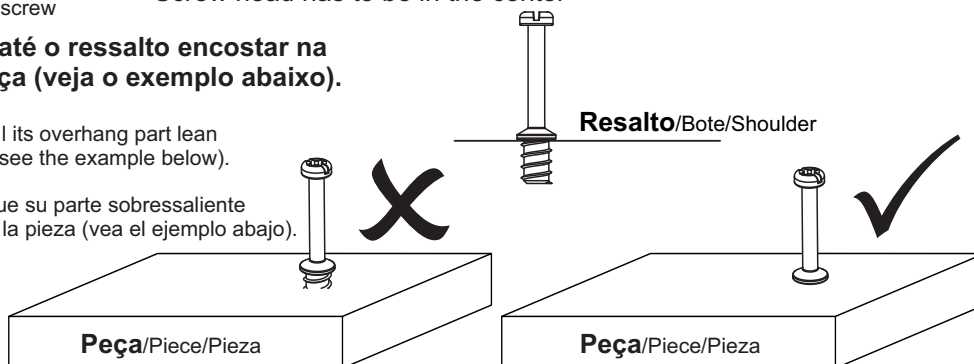

Passo 1

Paso/Step

PEÇA
Pieza/Piece

2 - LATERAL DIREITA x1

5 - PRATELEIRA MAIOR x1

FERRAGEM
Herraje/Hardware

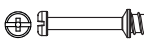
B  01

A  08

FERRAMENTA
Herramienta/Tool

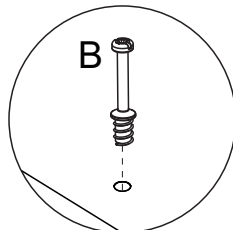
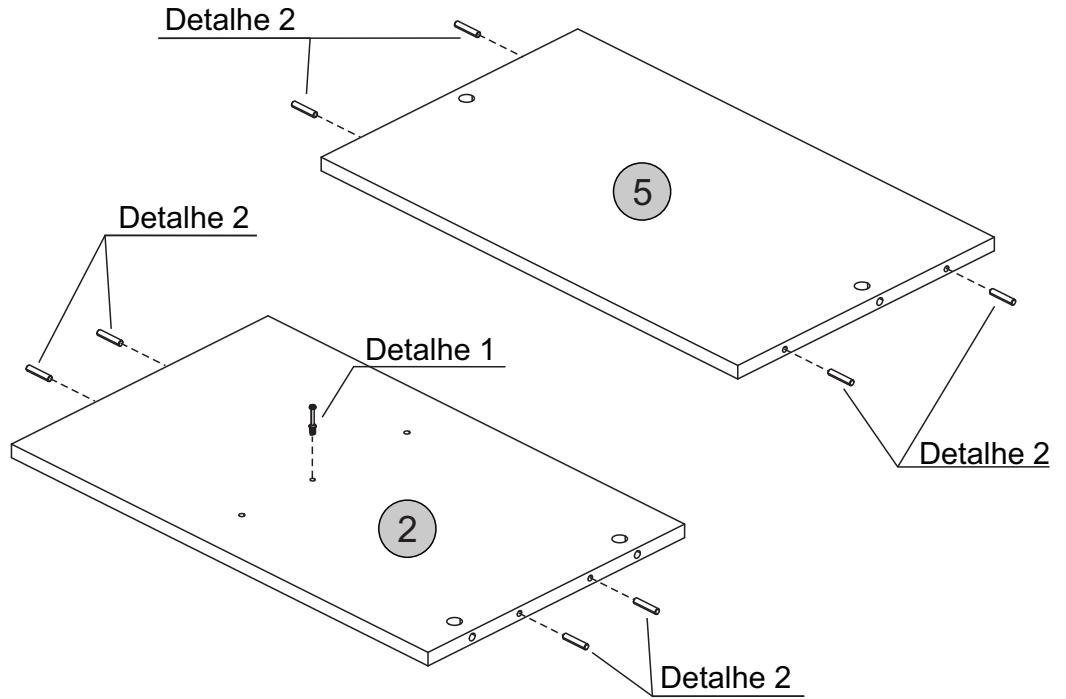
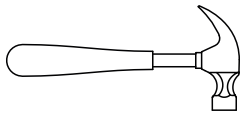
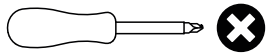

Detalhe 1
Detalle/Detail

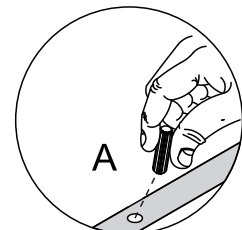
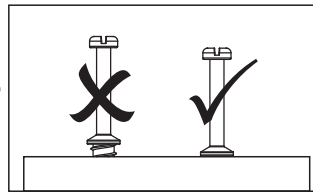

Detalhe 2
Detalle/Detail

Passo 2

Paso/Step

PEÇA
Pieza/Piece

3 - LATERAL ESQUERDA x1

FERRAGEM
Herraje/Hardware

A  04

H  02

G  02

M  04

FERRAMENTA
Herramienta/Tool

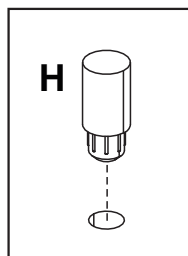
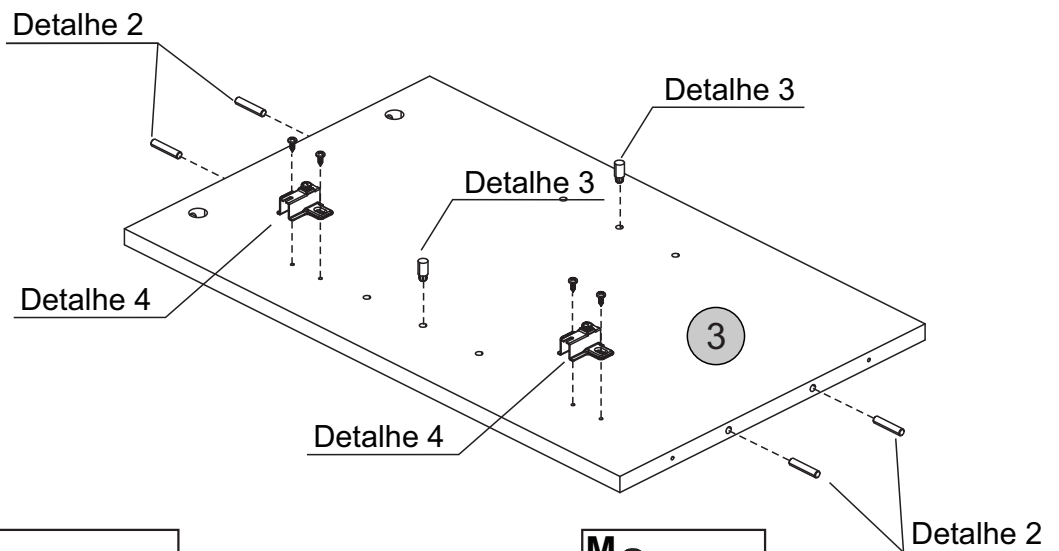
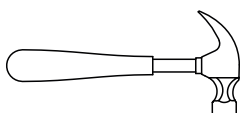
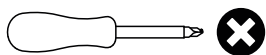

Detalhe 3
Detalle/Detail

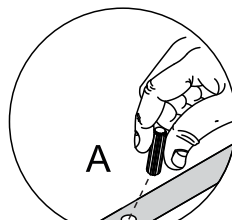

Detalhe 2
Detalle/Detail

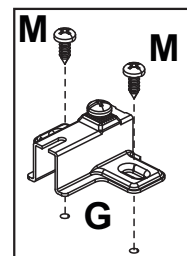

Detalhe 4
Detalle/Detail

Passo 3

Paso/Step

PEÇA

Pieza/Piece

9 - Divisão x1

FERRAGEM

Herraje/Hardware

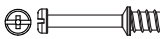
B  01

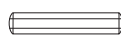
A  04

FERRAMENTA

Herramienta/Tool

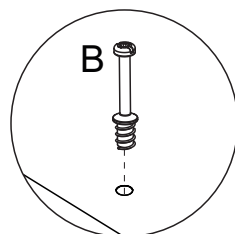
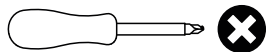

Detalhe 1
Detalle/Detail

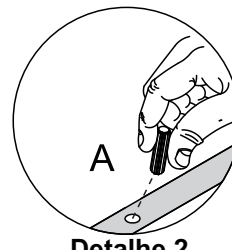
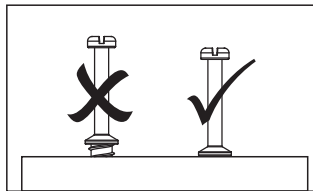

Detalhe 2
Detalle/Detail

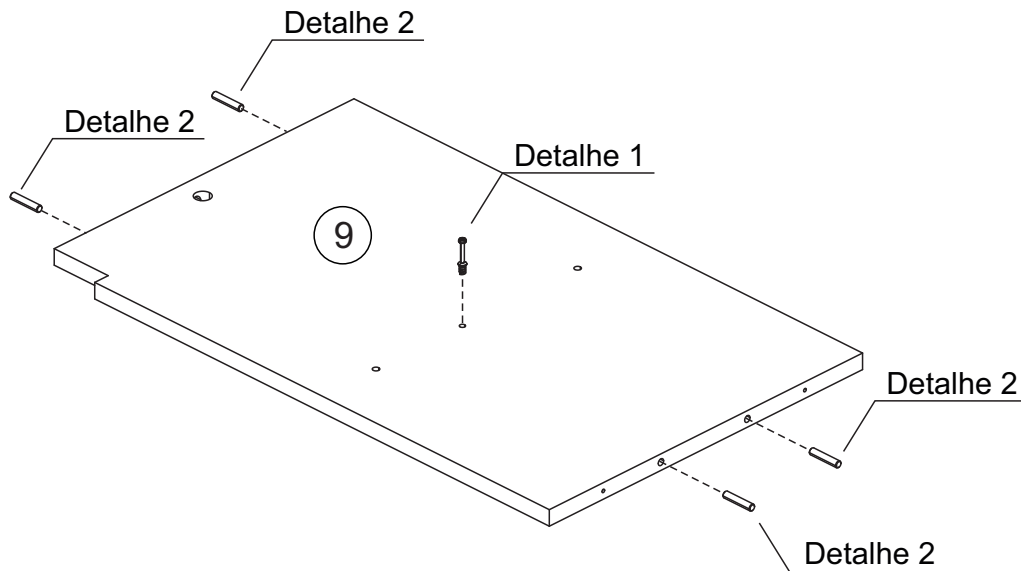

Passo 4

Paso/Step

PEÇA

Pieza/Piece

9 - Divisão x1

FERRAMENTA

Herramienta/Tool

H  02

FERRAMENTA

Herramienta/Tool

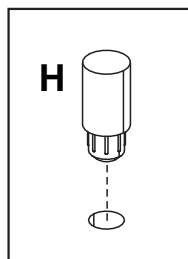
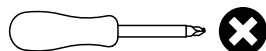

Detalhe 3
Detalle/Detail

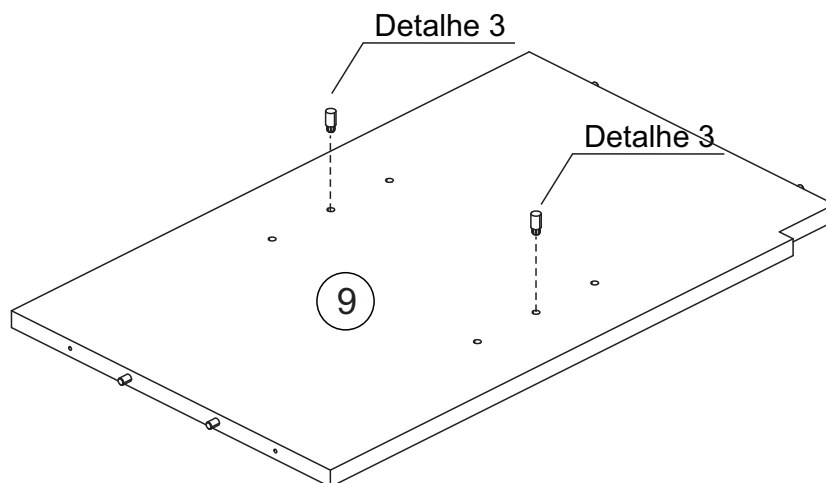

Passo 5

Paso/Step

PEÇA
Pieza/Piece

1 - TAMPO x1

7 - TRAVESSA x1

FERRAGEM
Herraje/Hardware

B  05

M  05

N  02

O  03

FERRAMENTA
Herramienta/Tool

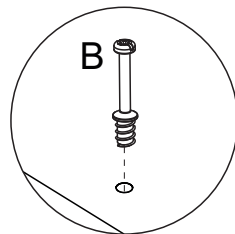
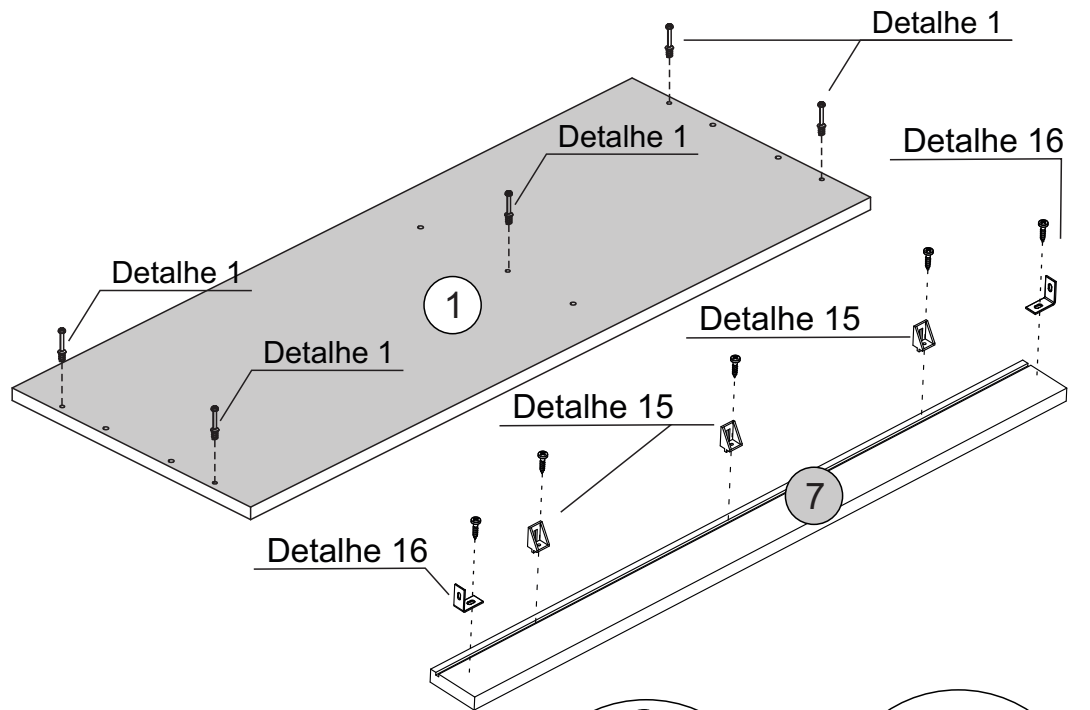
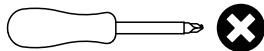

Detalhe 1
Detalle/Detail

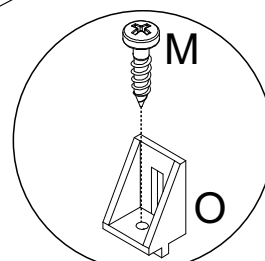
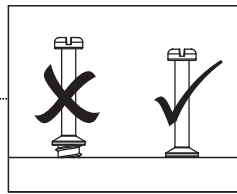

Detalhe 15
Detail/Detalle

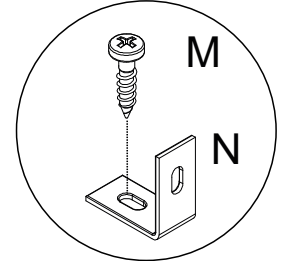

Detalhe 16
Detail/Detalle

Passo 6

Paso/Step

PEÇA
Pieza/Piece

9 - DIVISÃO x1

2 - LATERAL DIREITA x1

5 - PRATELEIRA MAIOR x1

FERRAGEM
Herraje/Hardware

C  02

FERRAMENTA
Herramienta/Tool

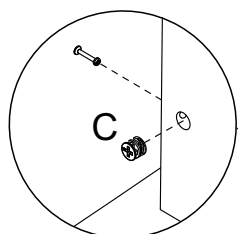
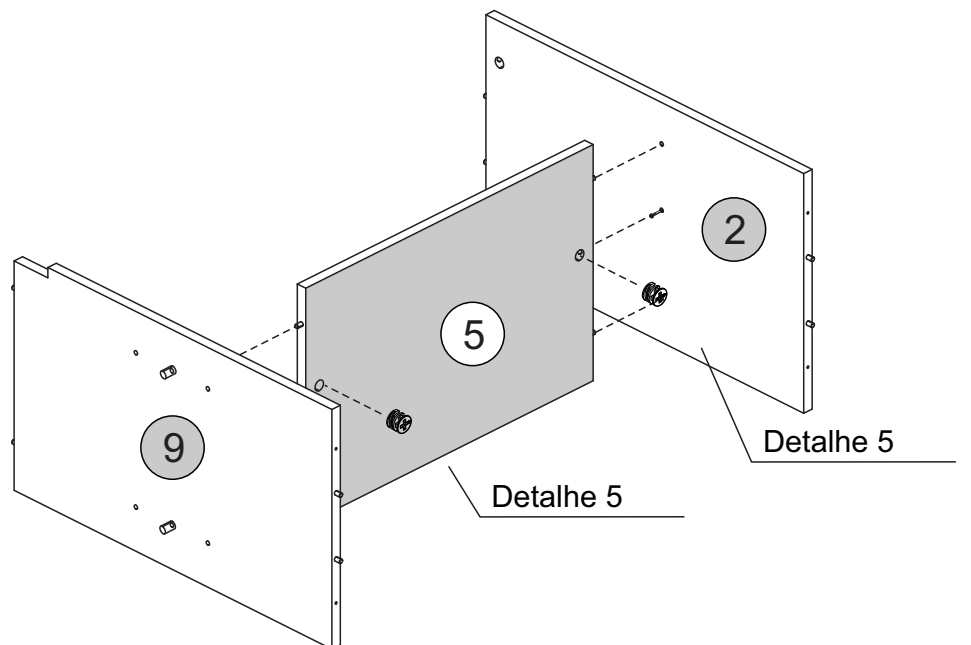
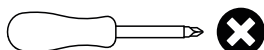

Detalhe 5
Detalle/Detail

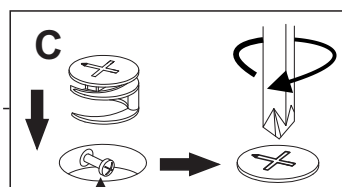

Cabeça do parafuso precisa estar no centro
La cabeza del tornillo debe estar en el centro
Screw head has to be in the center

Passo 7

Paso/Step

PEÇA
Pieza/Piece

3 - LATERAL ESQUERDO x1

4 - BASE x1

FERRAGEM
Herraje/Hardware

E  06

FERRAMENTA
Herramienta/Tool

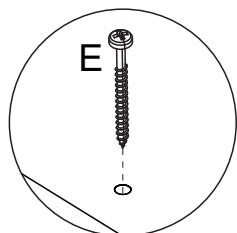
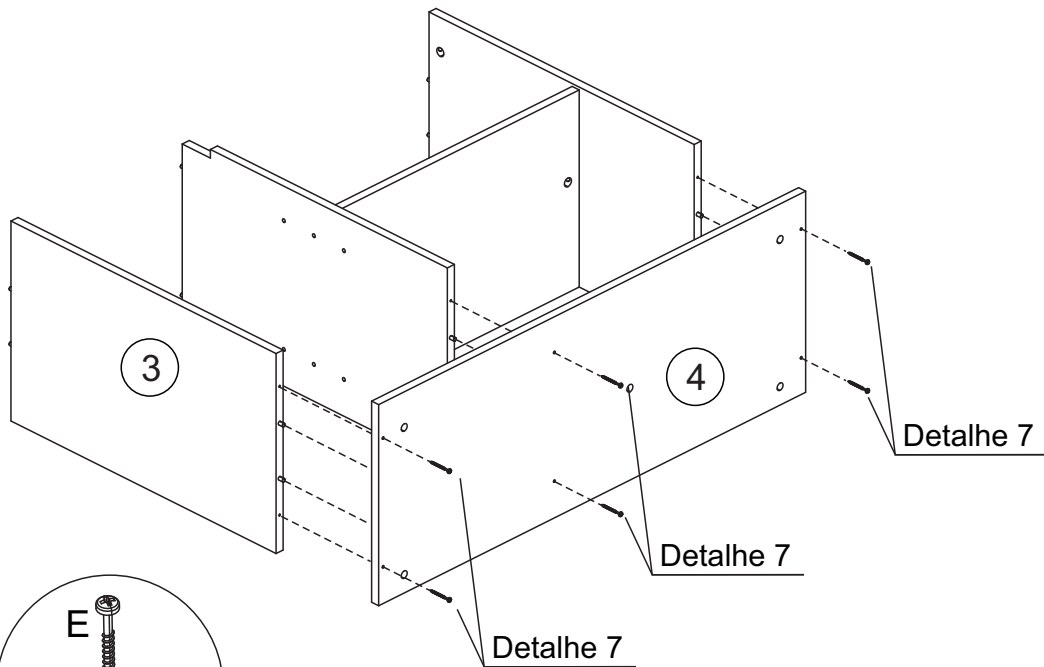
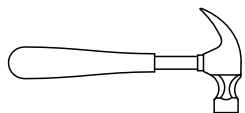
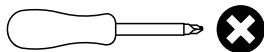

Detalhe 7
Detalle/Detail

Passo 8

Paso/Step

PEÇA
Pieza/Piece

7 - TRAVESSA x1

FERRAGEM
Herraje/Hardware

M  02

FERRAMENTA
Herramienta/Tool

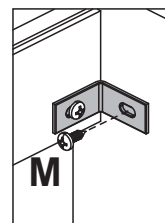
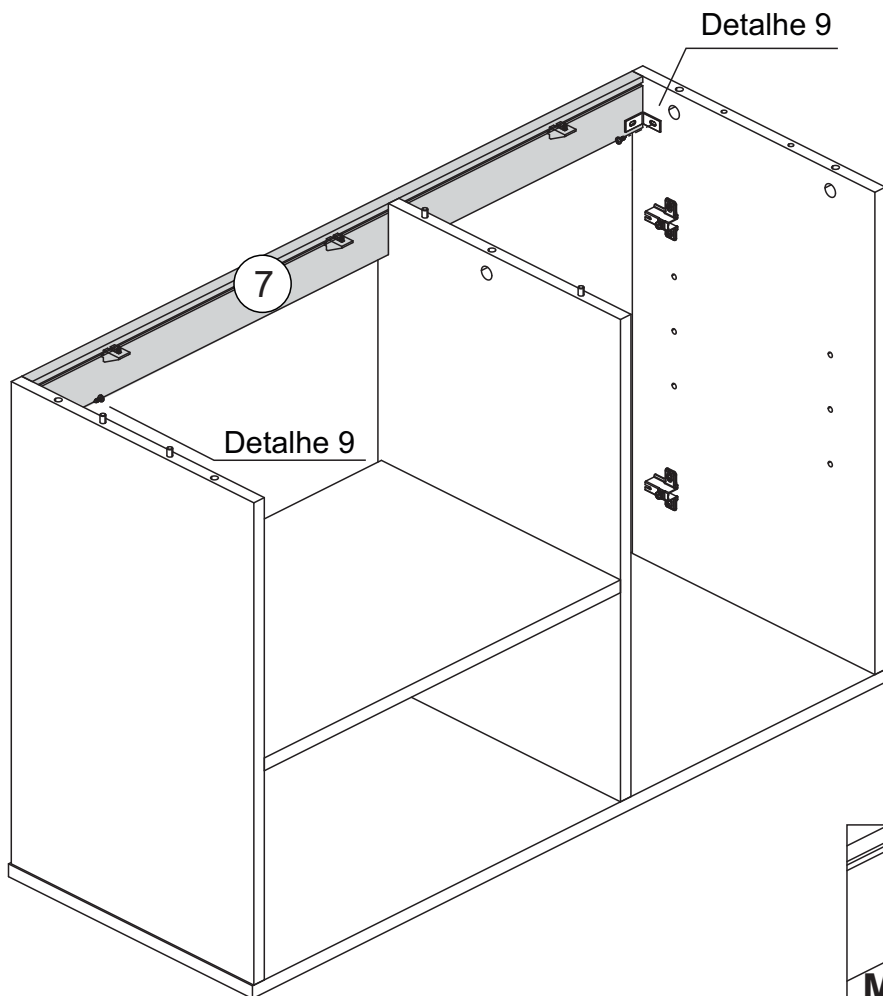
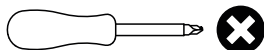

Detalhe 9
Detalle/Detail

Passo 9

Paso/Step

PEÇA Pieza/Piece

1 - TAMPO x1

FERRAGEM Herraje/Hardware

M  03

C  05

FERRAMENTA Herramienta/Tool

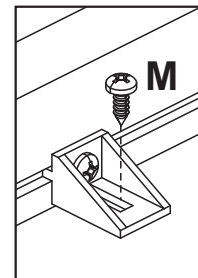
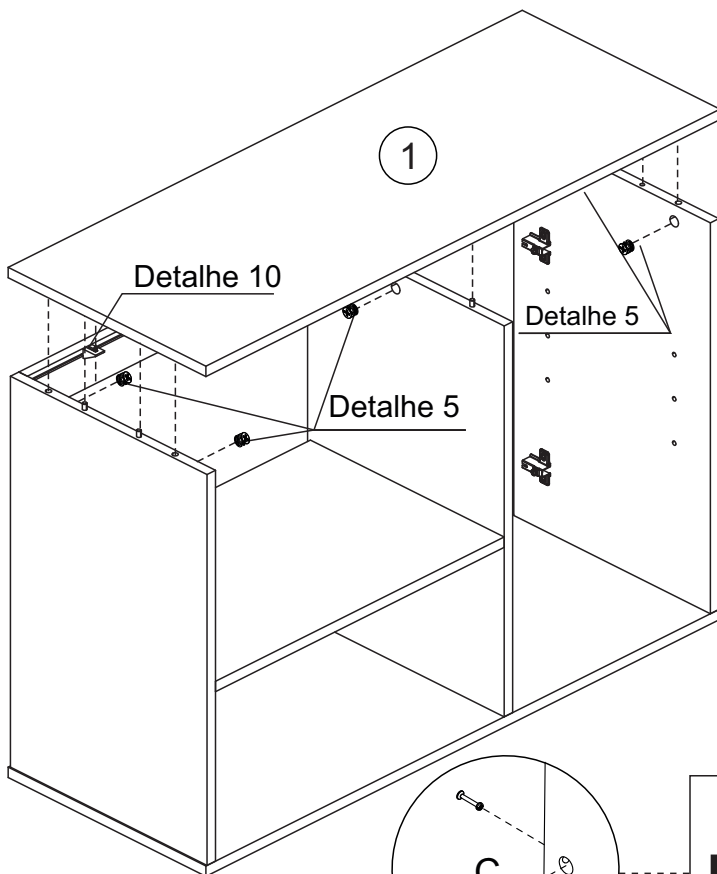
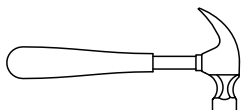
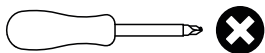

Detalhe 10
Detalle/Detail

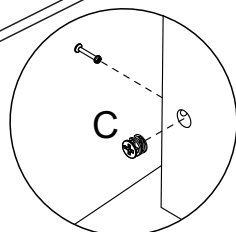

Detalhe 5
Detalle/Detail

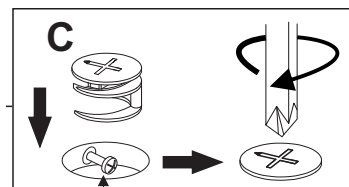

Cabeça do parafuso precisa estar no centro
La cabeza del tornillo debe estar en el centro
Screw head has to be in the center

Passo 10

Paso/Step

PEÇA Pieza/Piece

8 - TRASEIRO x1

FERRAGEM Herraje/Hardware

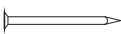
K  14

FERRAMENTA Tool/Herramienta

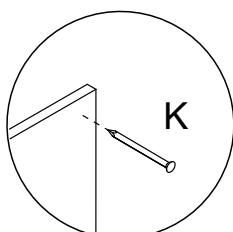
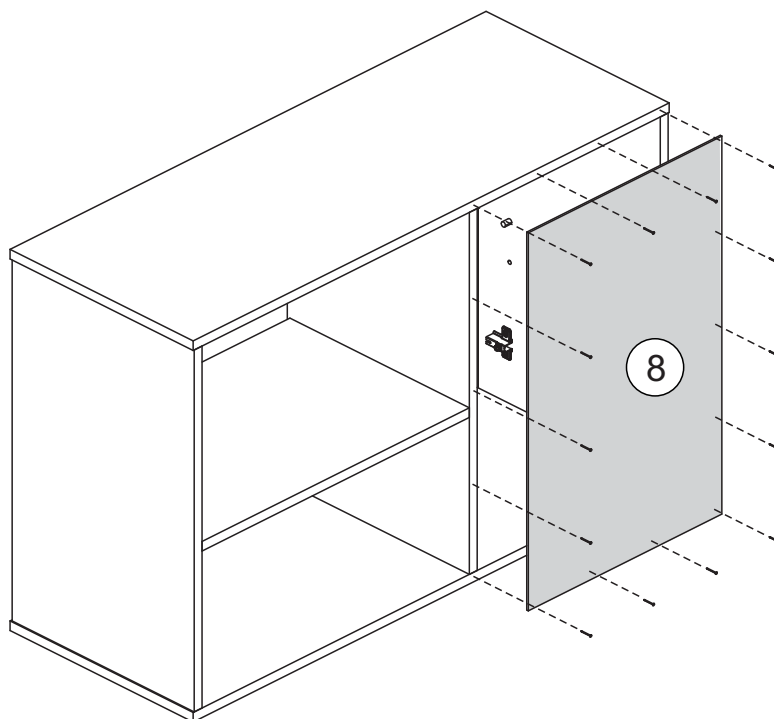
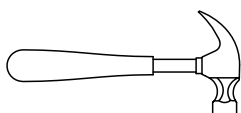

Detalhe 10
Detalle/Detalle

Passo 11

Paso/Step

PEÇA

Pieza/Piece

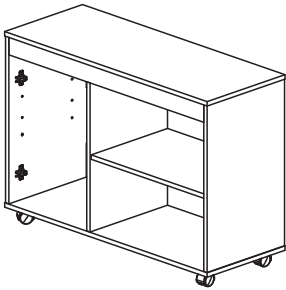

FERRAGEM

Herraje/Hardware

P



05

Q



05

FERRAMENTA

Herramienta/Tool

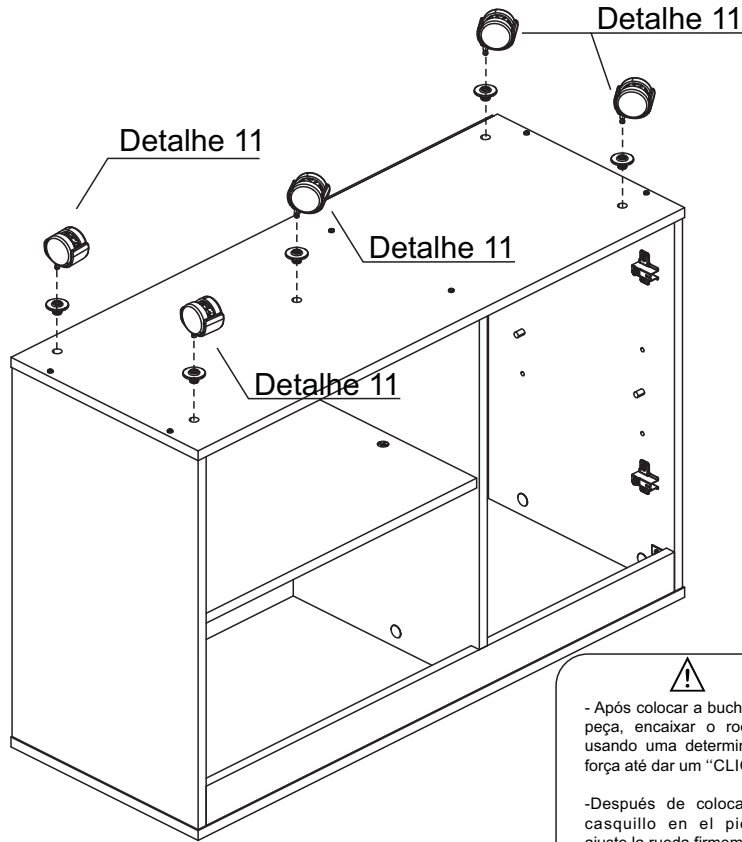
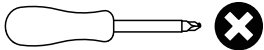

Dúvidas na fixação dos rodízios?
Assista o vídeo de montagem!

Dudas sobre la fijación de las ruedas?
Asista al código de montaje!

Doubts in fastening the casters?
Watch the assembly video!



- Após colocar a bucha na peça, encaixar o rodízio usando uma determinada força até dar um "CLICK".

- Después de colocar el casquillo en el pieza, ajuste la rueda firmemente hasta que haga clic.

- After placing the bushing on the piece, fit the caster tightly until it clicks.

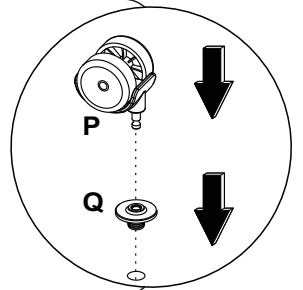

Detalhe 11
Detail/Detalle

Passo 12

Paso/Step

PEÇA

Pieza/Piece

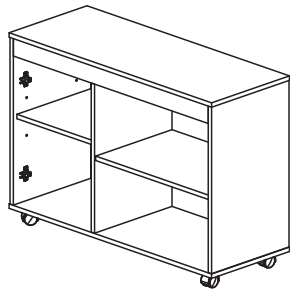

6 - PRATELEIRA MÓVEL x1

FERRAGEM
Herraje/Hardware

FERRAMENTA
Herramienta/Tool

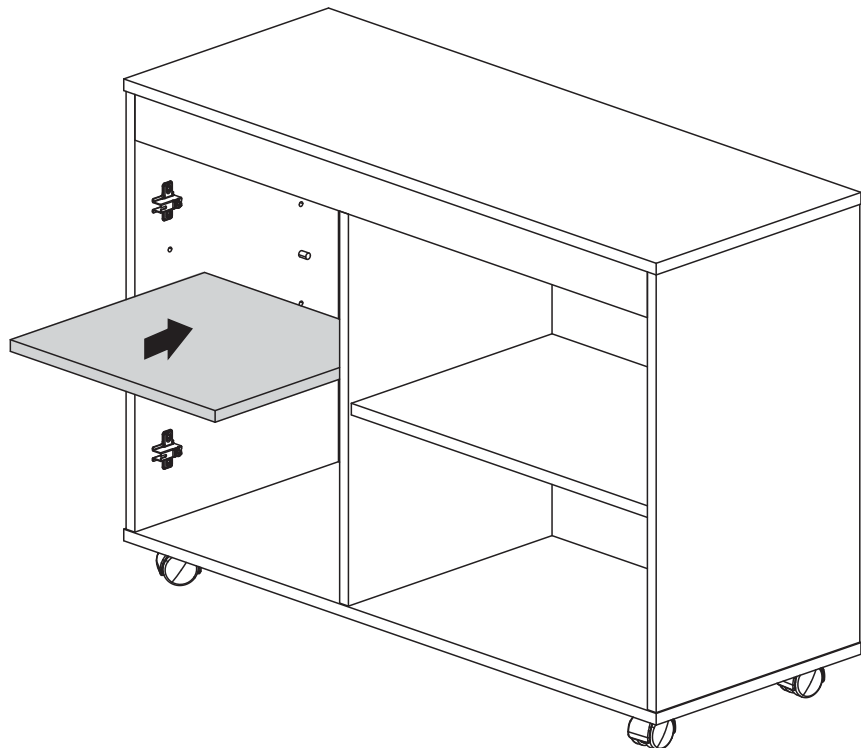
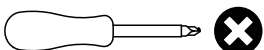

Passo 13

Paso/Step

PEÇA
Pieza/Piece

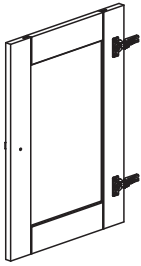

10 - PORTA x1

FERRAGEM
Herraje/Hardware

M  04

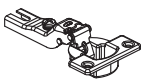
F  02

J  01

L  01

FERRAMENTA
Herramienta/Tool

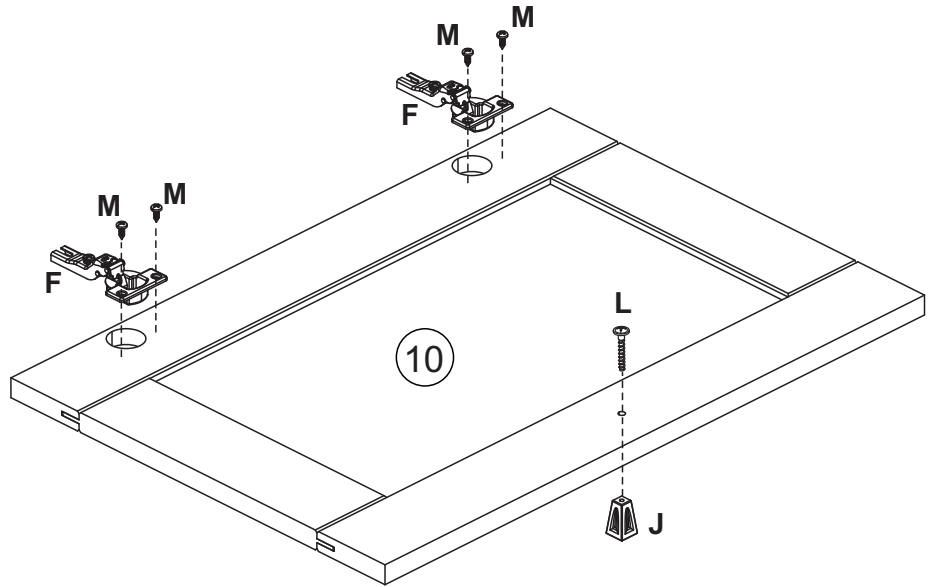
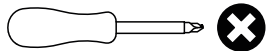

Passo 14

Paso/Step

PEÇA
Pieza/Piece

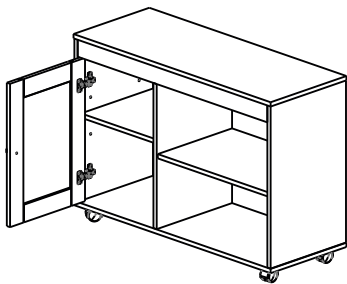

FERRAGEM
Herraje/Hardware

R  01

FERRAMENTA
Herramienta/Tool

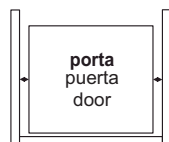
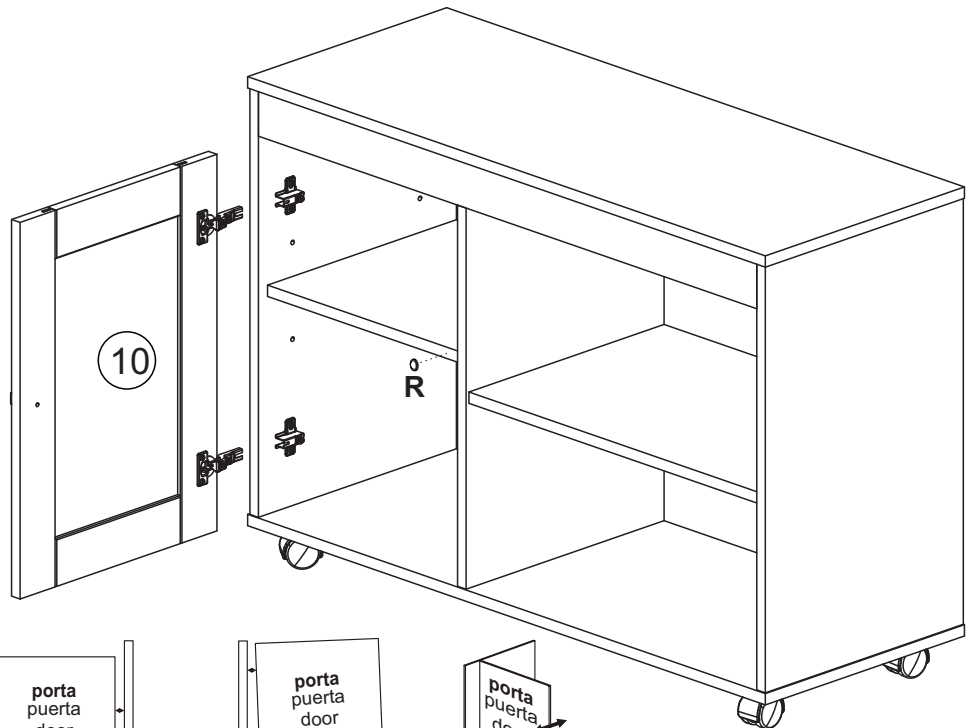
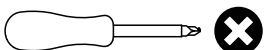

Ajuste de Largura
Ajuste de ancho
Width Adjustment



Ajuste Interno
Ajuste Interno
Internal Adjustment



Ajuste de Profundidade
Ajuste de profundidad
Depth Adjustment

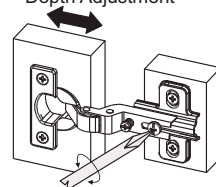
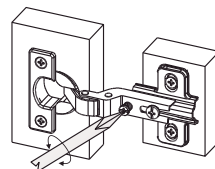
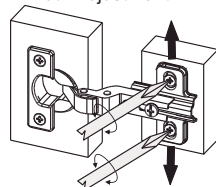

PEÇA
Pieza/Piece

FERRAGEM
Herraje/Hardware

FERRAMENTA
Herramienta/Tool

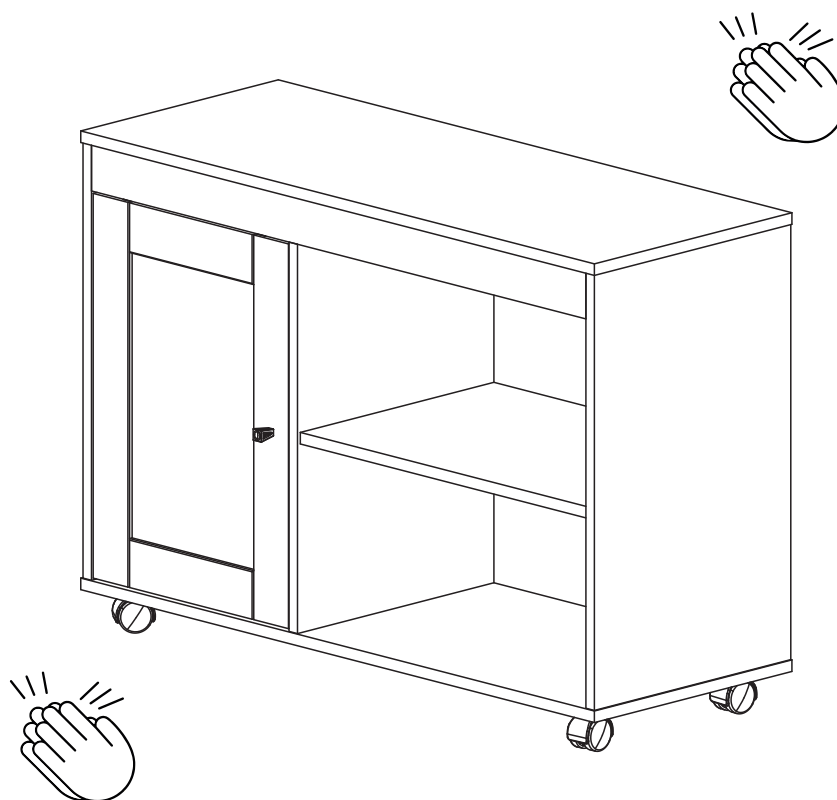

Parabéns, você montou seu móvel! Agora é só decorar sua casa e aproveitar!

Queremos ver como ficou o móvel Artely do seu jeito... Marque a gente com a #meuartely. Ficaremos felizes em compartilhar!

Ah, e se tiver qualquer dúvida, sugestão ou comentário, entra em contato com a gente pelo nosso site www.artely.com.br.

¡Congratulaciones, montaste tu mueble! ¡Ahora solo decora tu casa y disfruta!

Queremos ver este producto en tu hogar, a tu manera... Utilice #meuartely, ¡ficaremos encantados de compartir tu foto!

Si tienes alguna duda, sugerencia o comentario, contáctenos a través de nuestro sitio web www.artely.com.br.

Congratulations, you've assembled your new furniture! Decorate your home and enjoy!

We want to see how this product is in your home... Use #meuartely, we will be happy to share your picture!

If you have any doubt, suggestion or comment, get in touch with us through our website www.artely.com.br.