

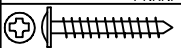

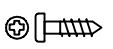

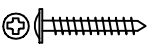







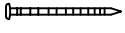

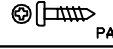





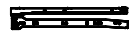























COD. ASSISTENCIA	LEGENDA					
	PEÇAS	QTD	COMPR	LARG	ESPE	CAIXA
01	PORTAS MENORES	02	1417mm	431mm	15mm	B
02	FRENTE DE GAVETA	02	864mm	260mm	15mm	B
03	LATERAL DIREITA	01	2120mm	480mm	15mm	A
04	LATERAL ESQUERDA	01	2120mm	480mm	15mm	A
05	CHAPÉU	01	1771mm	480mm	15mm	C
06	BASE	01	1771mm	480mm	15mm	C
07	DIVISÓRIA	01	1973mm	444mm	15mm	A
08	PRATELEIRAS	02	870mm	403mm	15mm	C
09	TAMPO DE GAVETA	01	870mm	403mm	15mm	C
10	PRATELEIRA CALCEIRO	01	886mm	192mm	15mm	C
11	PORTA DE CORRER	01	1961mm	879mm	15mm	B
12	LATERAL DE GAVETA	04	360mm	180mm	15mm	C
13	CABECEIRA DE GAVETA	02	816mm	180mm	15mm	C
14	RODAPÉ DIANTEIRO	01	1771mm	96mm	15mm	C
15	RODAPÉ TRASEIRO	01	1771mm	96mm	15mm	C
16	RODAPÉ INTERNO	01	424mm	96mm	15mm	A
17	SARRAFO DAS PORTAS MENORES	01	870mm	50mm	25mm	C
18	RODAFORRO	01	1802mm	56mm	15mm	C
19	COSTA LARGA	01	1993mm	904mm	3mm	B
20	COSTA ESTREITA	01	1993mm	887mm	3mm	B
21	FUNDO DE GAVETA	02	829mm	358mm	3mm	C

	CÓD.	FERRAGEM	QTDE.
A	2592	 AM, BP, BR TE, FR/CN PARAFUSO FLANGE 4,0x40	32
A	4042	 TC, TIP, JA PARAFUSO FLANGE 4,0x40	32
B	1828	 PARAFUSO PAINELA 3,5x14	04
C	14773	 PARAFUSO FLANGE 3,5x25	08
D	4214	 PARAFUSO CHATO 3,5x14	67
E	5256	 PARAFUSO CHATO 4,0x20	08
F	58		01
G	107	 PREGOS 10X10	108
H	1802	 CAVILHA 6x30MM	58
I	41921	 SUPORTE PARA CABIDEIRO	04
J	61971	 PARAFUSO PARA DOBRADIÇA	24
K	62450	 DOBRADIÇA MINI SUPER CURVA 26MM	06
L	62451	 CALÇO 12MM	06
M	85	 "L" DE METAL	10
N	18458	 SUPORTE TRIANGULAR PRETO	08
O	41	 COLA BRANCA EM BISNAGA	01

P	1423	 FIXADOR DE COSTA	16
Q	169	 CORREDEIRA 350MM (DE METAL) BRANCO	02
R	84821	 ROLIÇO ALUMINIO FRISADO Ø7,8	02
S	40534	 GOTA DE SILICONE C/ LOGO "K"	04
T	7981	 PUXADOR CROMADO 256MM	04
T	44752	 FR/CN PUXADOR CHAMPAGNE FOSCO 256MM	04
U	9371	 PUXADOR DE CHAPA CROMADO	01
U	45146	 FR/CN PUXADOR DE CHAPA CHAMPAGNE	01
V	899	 CANTONEIRA	05
W	30945	 PARAFUSO MINIFIX	04
X	30950	 TAMBOR MINIFIX	04
Y	8090	 TAMPAS MINIFIX TECA ITALIA BP, BR	04
Y	2347	 TAMPAS MINIFIX BRANCO AM	04
Y	14855	 TAMPAS MINIFIX CARVALLE TC	04
Y	3329	 TAMPAS MINIFIX TABACO TE	04
Y	7202	 TAMPAS MINIFIX TECA FR	04
Y	51256	 TAMPAS FURTO FREIJO 19MM JA	04
Y	44674	 TAMPAS FURTO JACRANDA 19MM CN	04
Y	81770	 TAMPAS FURTO CANELA 19MM	04

Z	9431	 ROLETE SEM REGULAGEM	01
AA	9431	 ROLETE COM REGULAGEM	01
AB	9431	 GUIA METALICO	02
AC	21825	 TRILHO DE ALUMINIO 1770MM	01
AD	21828	 TRILHO PLASTICO ALUMINIO 1770MM	01
AE	25569	 BARRA DE METAL NOCE PORTA DE CORRER 196,1CM	01
AE	25568	 BARRA DE METAL CARVALLE PORTA DE CORRER 196,1CM	01
AE	51813	 FR/CN BARRA DE METAL CHAMPAGNE PORTA DE CORRER 196,1CM	01
AE	28190	 BARRA DE METAL BRANCA PORTA DE CORRER 196,1CM	01
AF	25566	 CONJUNTO PE PLASTICO UZ CARVALLE	01
AF	25567	 CONJUNTO PE PLASTICO UZ NOCE	01
AF	22971	 CONJUNTO PE PLASTICO UZ BRANCO	01
AF	36143	 CN/FR CONJUNTO PE PLASTICO UZ NATURE	01
AF	47057	 JA CONJUNTO PE PLASTICO UZ TABACO	01
AG	25565	 PERFIL "T" 8,2X2,3MM CROMADO Ø7,9MM	02
AG	51818	 FR PERFIL "T" 8,2X2,3MM CHAMPAGNE Ø7,9MM	02
SACO MÉDIO PARA COLOCAR PUXADORES			
SACO MÉDIO PARA ACESSÓRIO E DOBRADIÇAS			

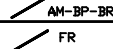
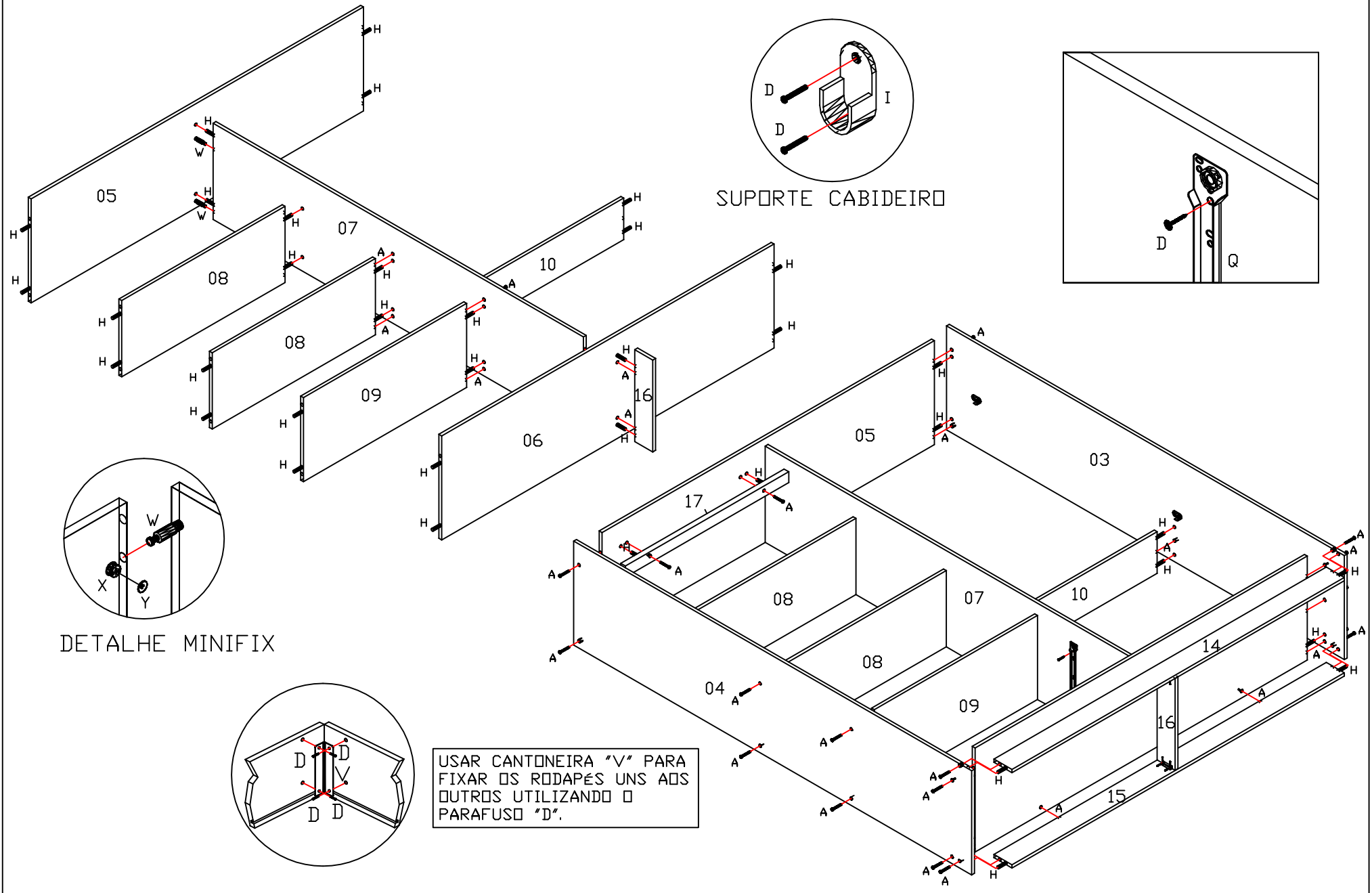

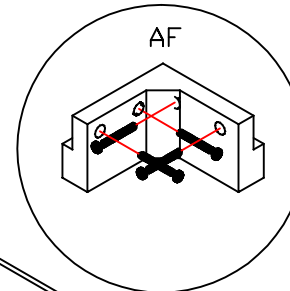
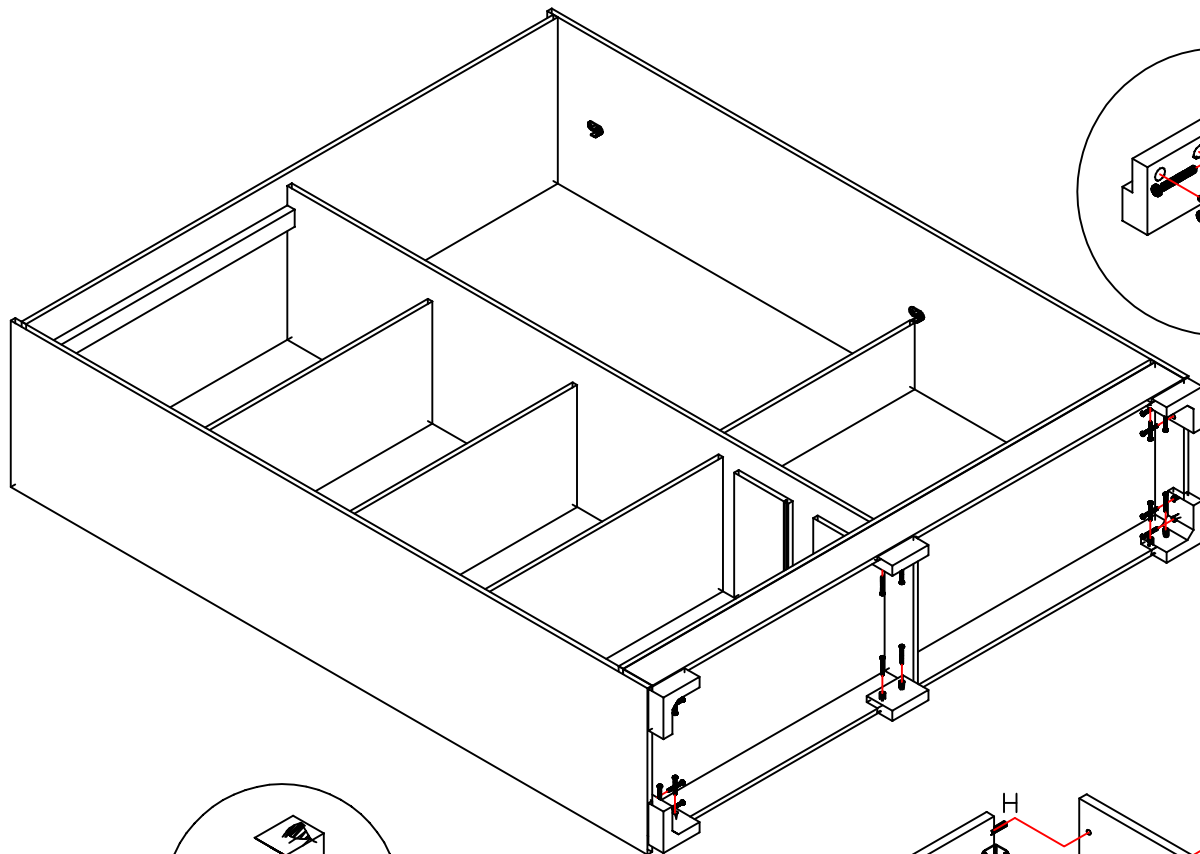

USAR CONJUNTO PÉ DE PLÁSTICO "AH" PARA FIXAR AS LATERAIS E BASE NOS RODAPÉS UTILIZANDO O PARAFUSO QUE ACOMPANHA O MESMO.

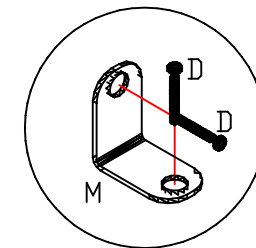

USAR L DE METAL "M" PARA FIXAR OS RODAPÉ FRONTAL NA BASE UTILIZANDO O PARAFUSO "D".

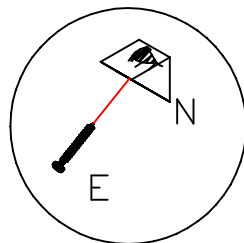

DETALHE DO SUPORTE DE GAVETA
ESTE DEVE SER FIXADO
ABAIXO DO FUNDO DE GAVETA
DOIS NA FRETE E DOIS ATRAS
APÓS A GAVETA ESTAR MONTADA

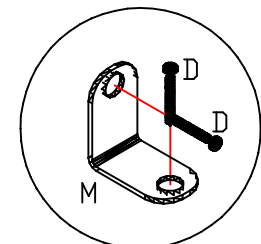
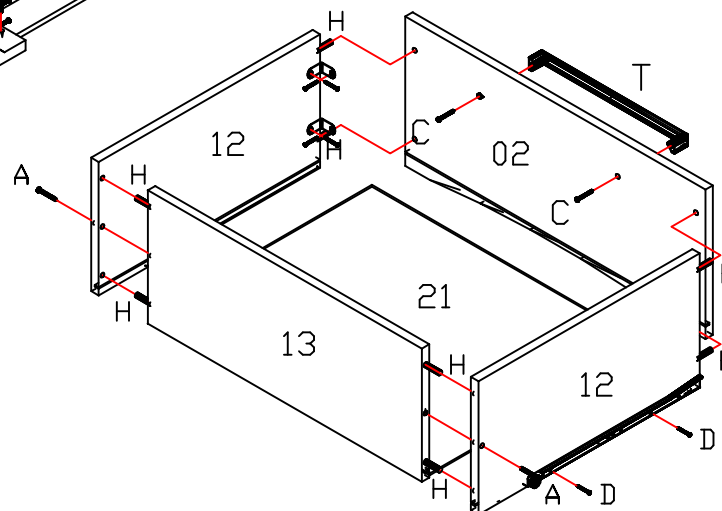

"L" DE METAL PARA
PRENDER A FRENTE
DE GAVETA

"Obs: Colocar os parafusos da corredeira pelo lado e não por baixo."

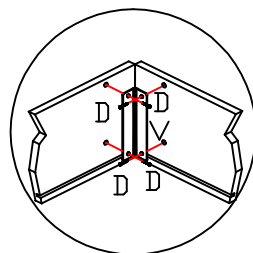
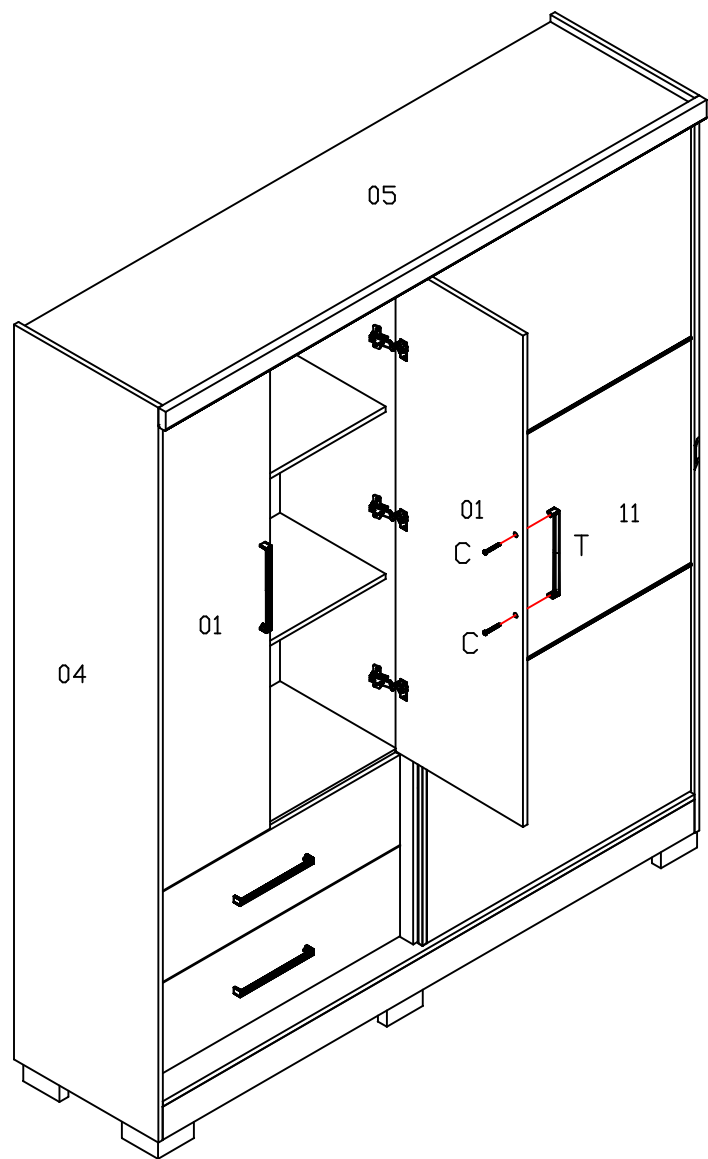

USAR CANTONEIRA "V" PARA FIXAR
O RODAFORRO NO CHAPEU
UTILIZANDO O PARAFUSO "D".

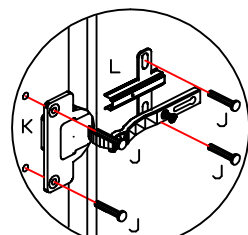

DOBRADIÇA

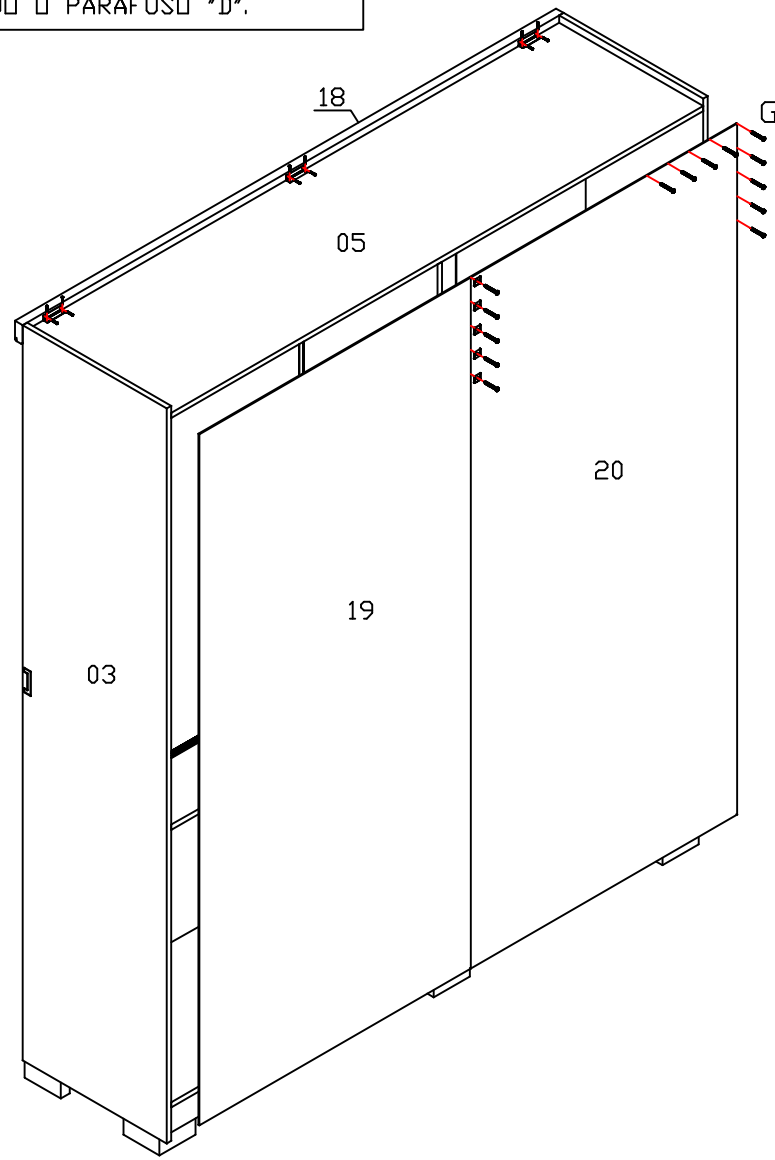
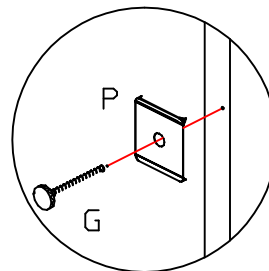

kappesberg ^{móveis}
www.kappesberg.com.br

Rua Emancipação 2000- Tupandi-RS
Fone: (51) 3635-8800
www.kappesberg.com.br

C533

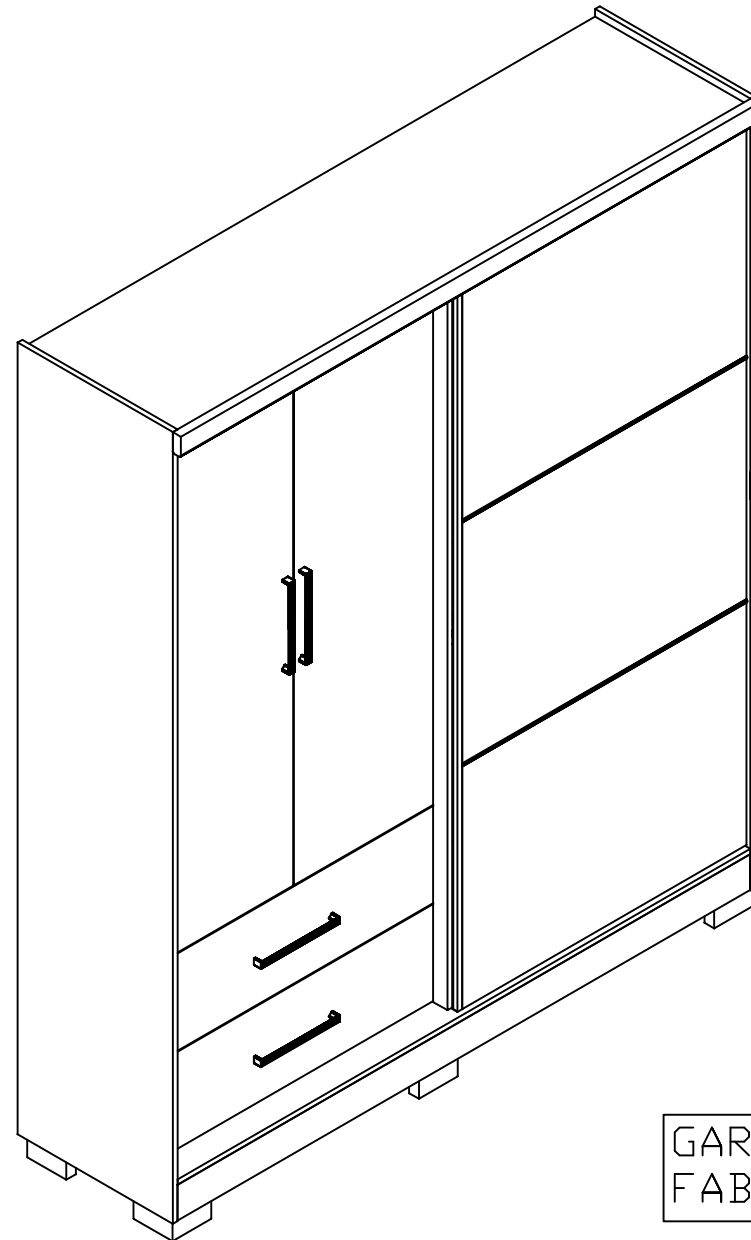

GARANTIA POR DEFEITOS DE
FABRICAÇÃO DE 03 MESES.

IMPORTANTE

C533

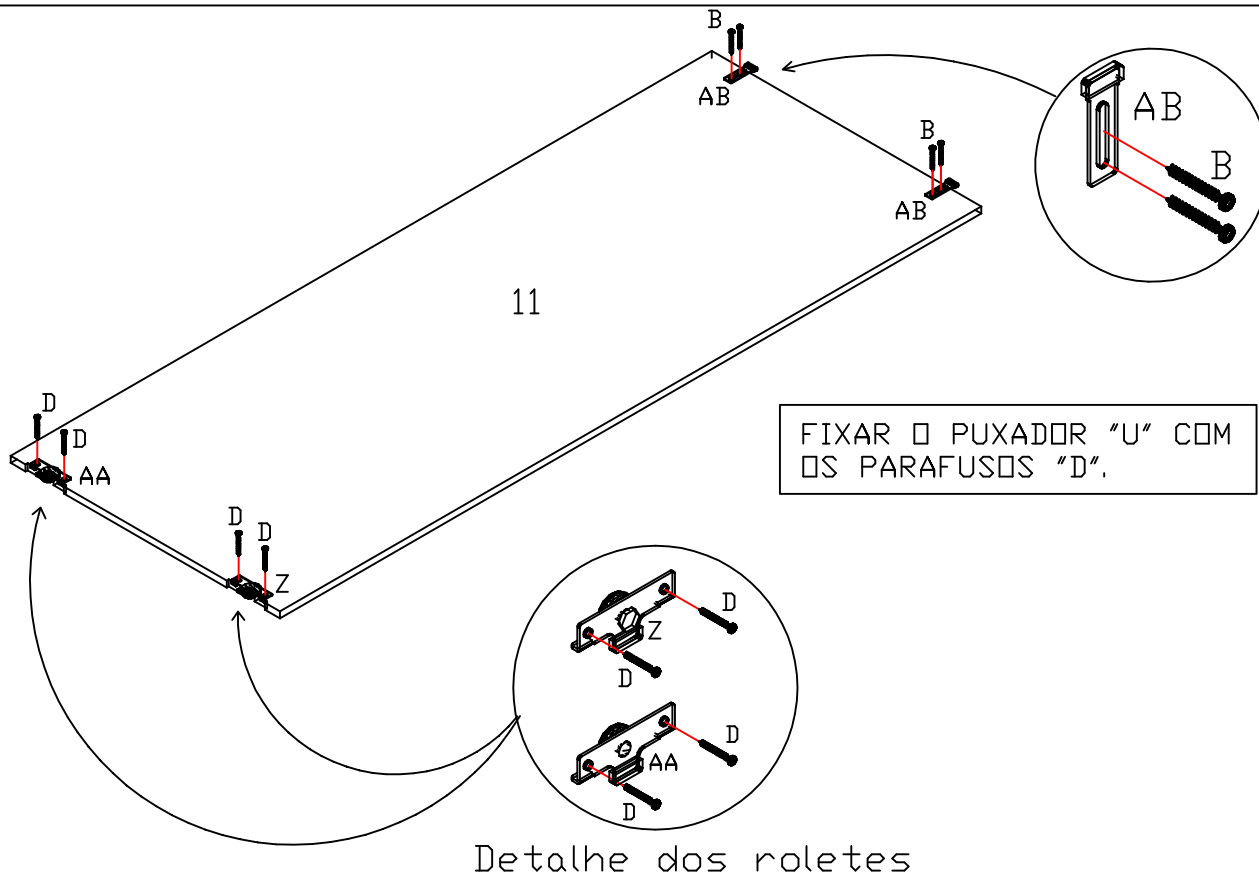

Detalhe dos roletes

Para melhor montar as portas coloque o rolete com regulagem "Z" no lado do puxador e o rolete sem regulagem "AA" no lado oposto do puxador. Os guias "Q" devem ser fixados com um parafuso "B", mais não deve ser apertado antes de encaixar a porta no trilho de alumínio. Após encaixar a porta no móvel levante o guia "AB" p/ dentro do trilho, mais não o preione demais contra o trilho (deixar uma folga entre o guia e o trilho, para que a porta deslize melhor) que está no chapéu e aperte bem o parafuso. Em seguida coloque o segundo parafuso em cada guia.

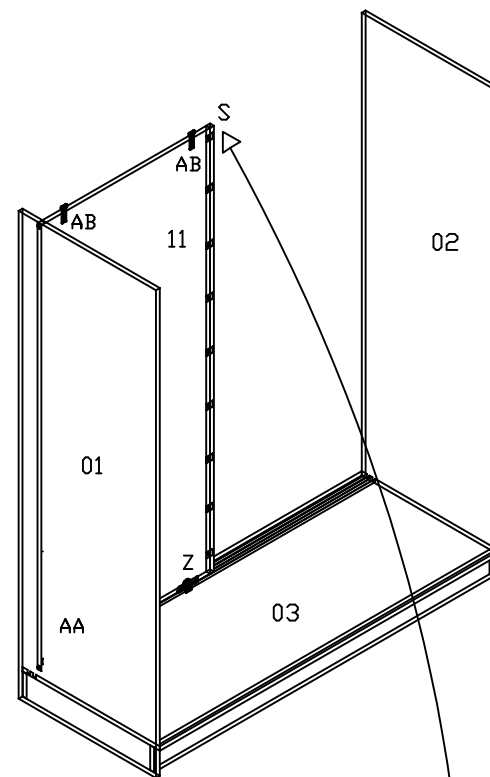

Detalhe do batente

Obs: No acessório contem 4 Gotas de Silicone "S" que devem ser colodas nas portas, para que as mesmas não batam com tanta força nas laterais e uma na outra.

- ① As portas não devem bater nas laterais do roupeiro. Devem parar 2mm antes. Para isso regule o batente plástico que está colocado dentro dos trilhos de alumínio do chapéu.
- ② A porta não pode bater no puxador da outra porta. Ajuste o batente.