

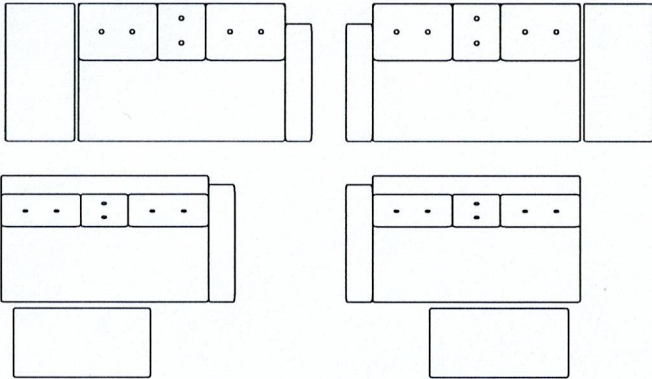

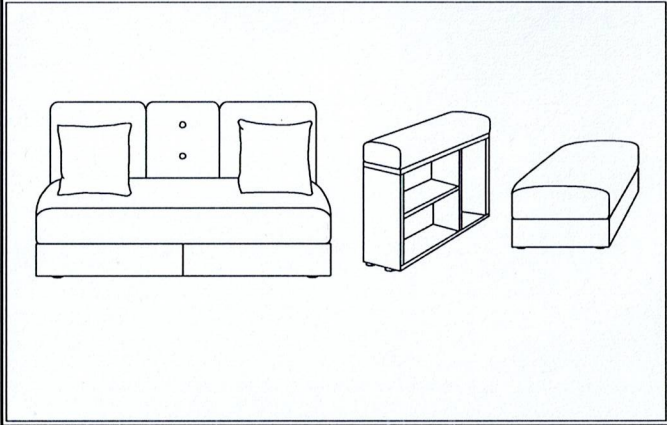

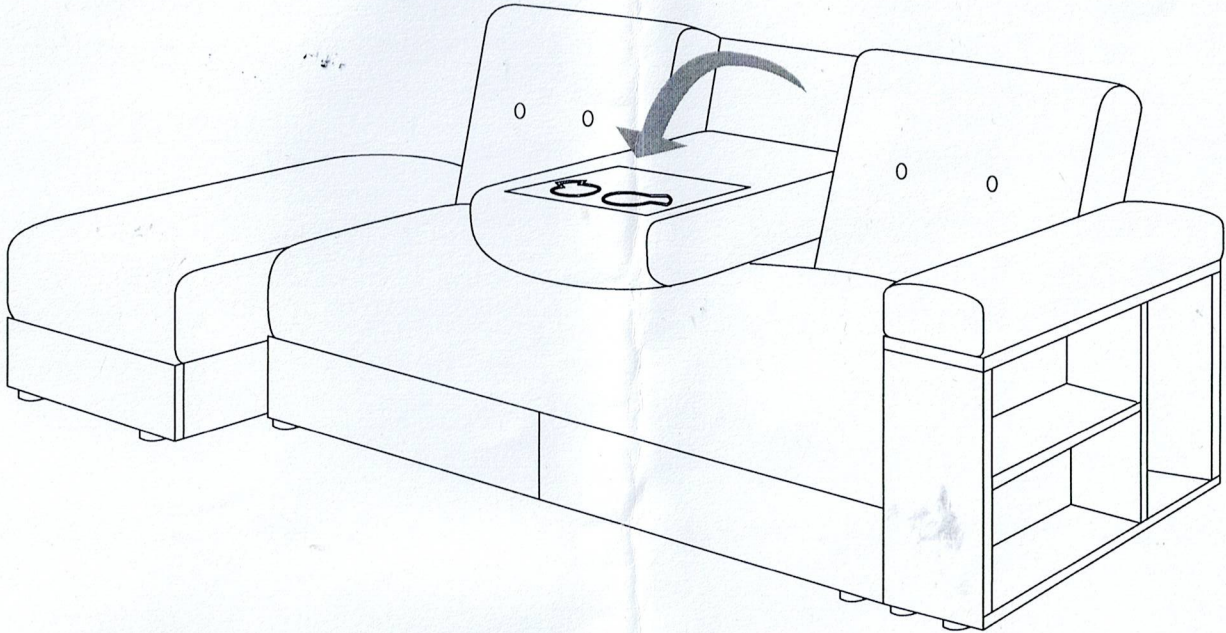

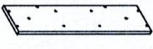

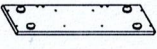

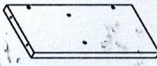
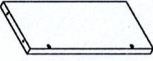
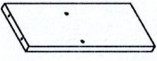
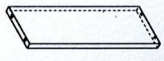
# ASSEMBLY INSTRUCTION SS001K



### HARDWARE LIST

			
A×1	B×1	C×1	D×1
			
E×1	F×1	G×1	H×1
			M5
I×4	J×18	K×1	L×3
			
M×3	N×19	O×1	

### STEP 1

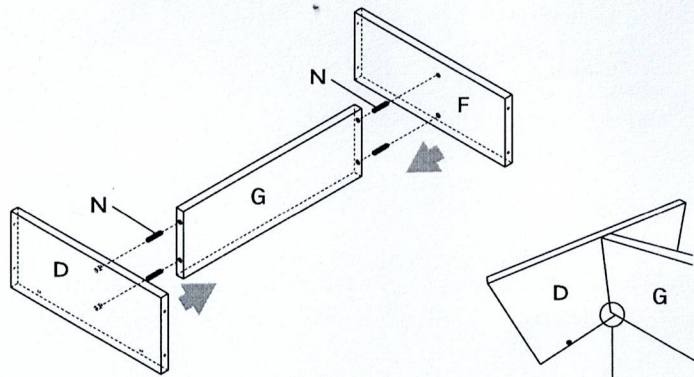

### STEP 2

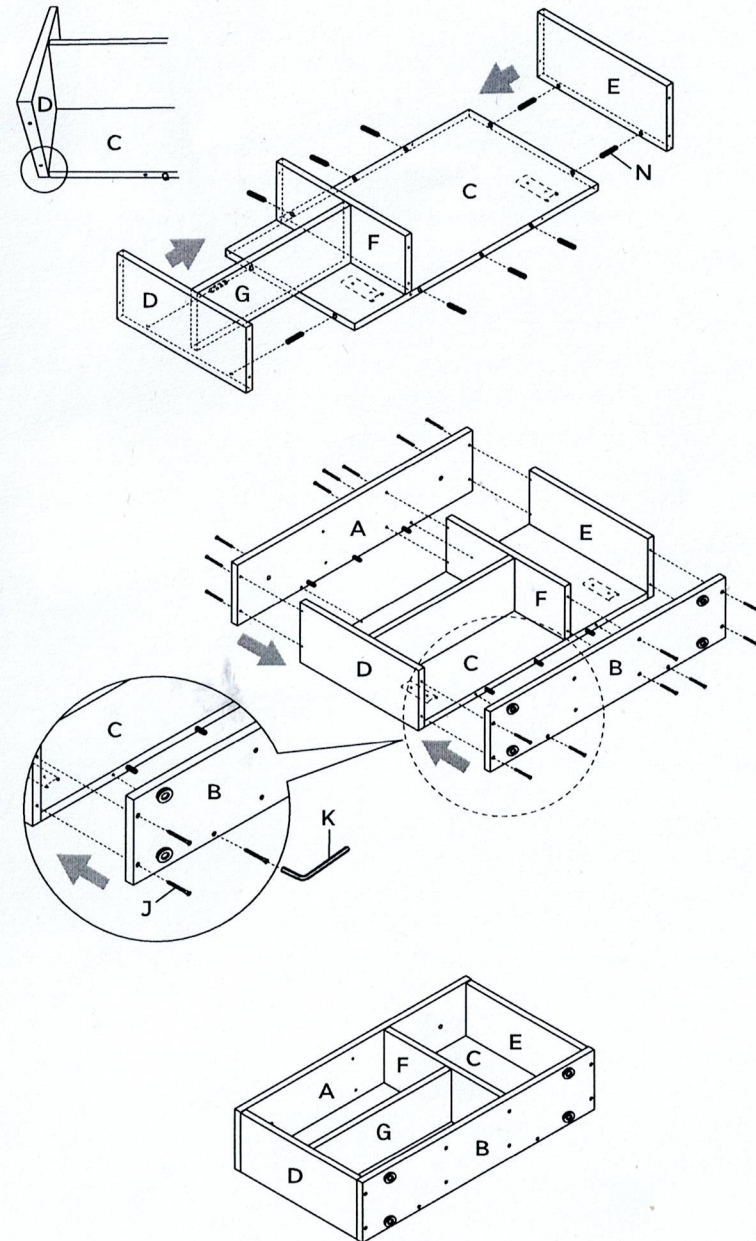

### STEP 3

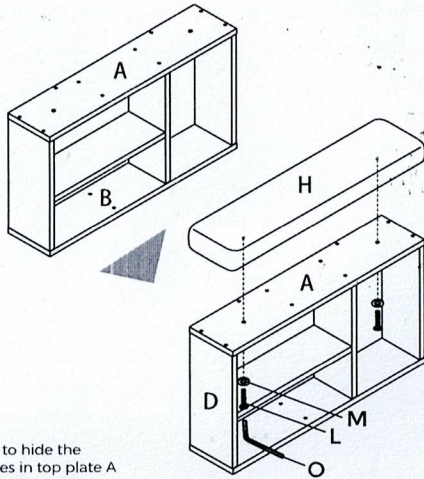

If you want to hide the unused holes in top plate A and bottom plate B, use the I sticker according to your preference.

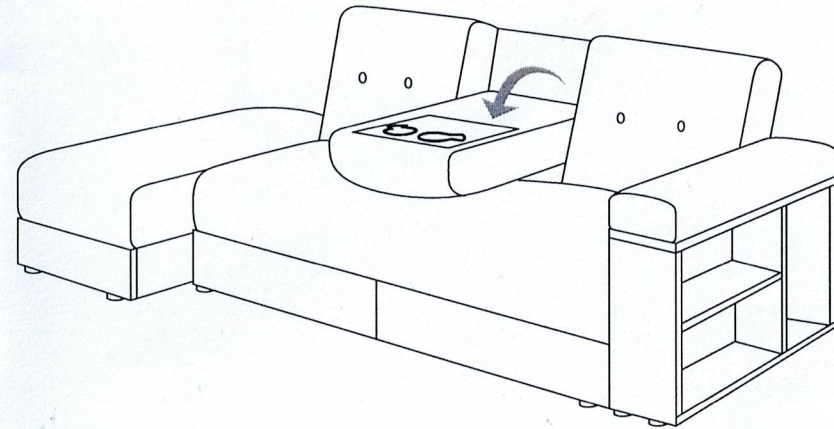

### STEP 4

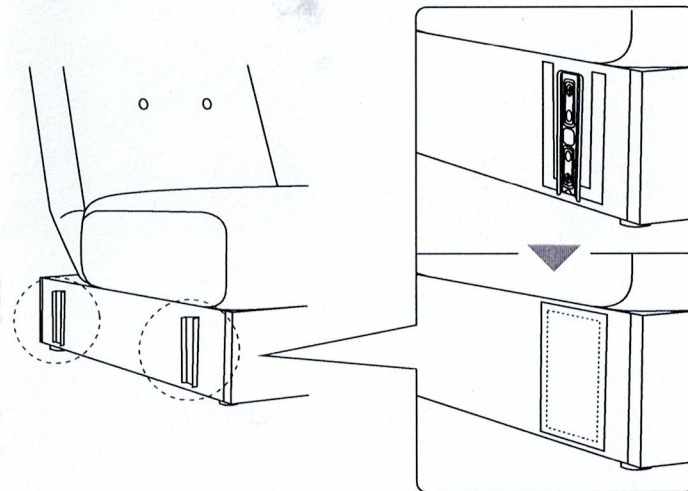
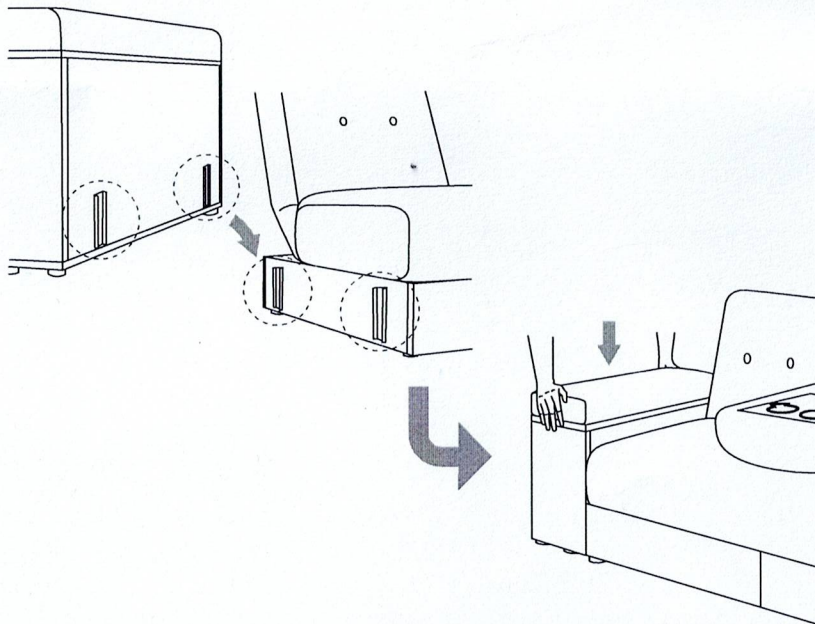

When connecting metal parts are not used, attach a metal part cover to prevent the connecting metal parts from being exposed.

**Drawer removal method** Please confirm the black lever on the left and right track of the drawer.

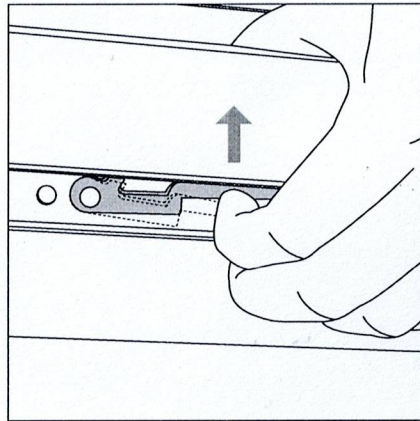

Pull up the black lever on the left side

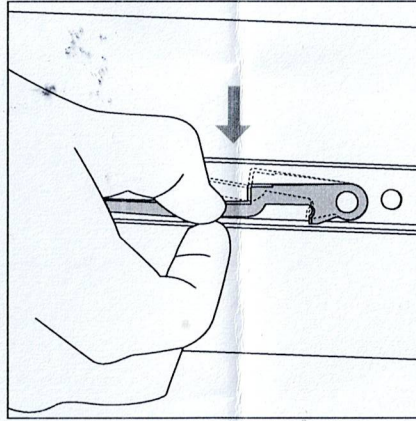

Press down the black lever on the right side

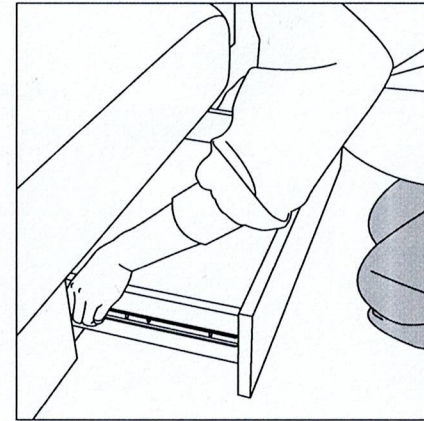

Pull it out with both hands.

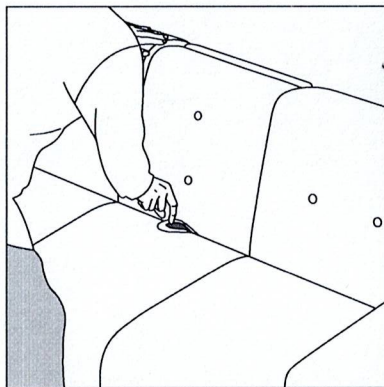

Pull the ribbon out of the cushion  
ribbon hidden inside of the cushion

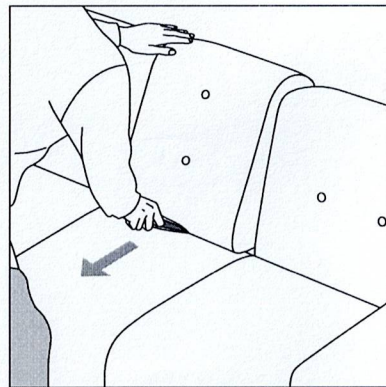

Raise up the cushion little bit with the ribbon

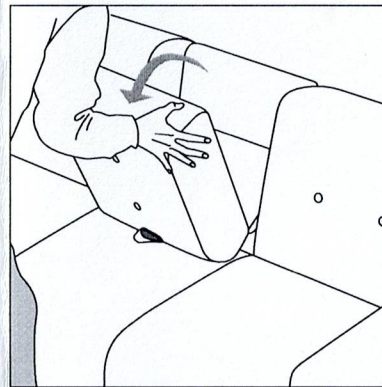

Hold up the cushion with hands  
don't pull the ribbon anymore

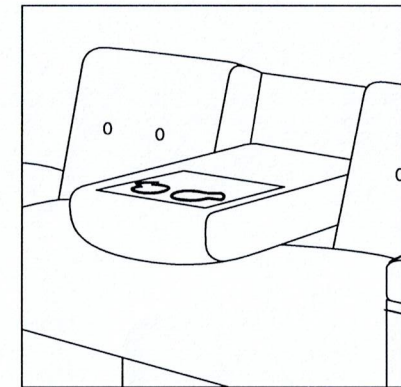

Stretch out the cushion to expose the cupholder

Sofa Bed

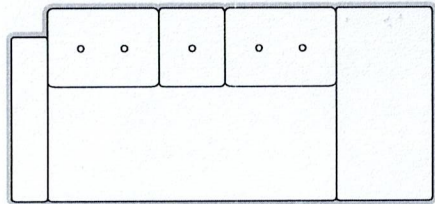
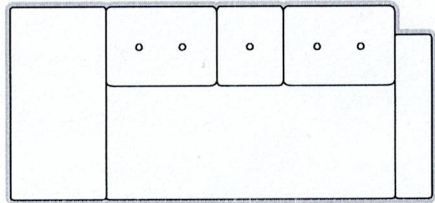

Sofa

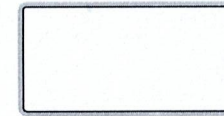
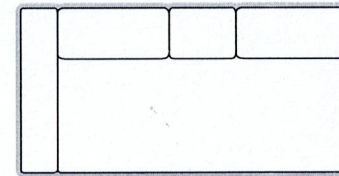
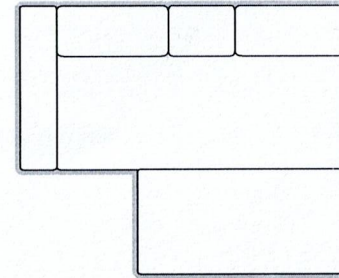
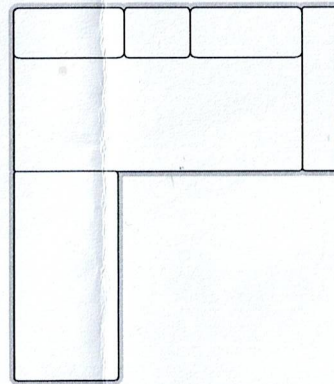
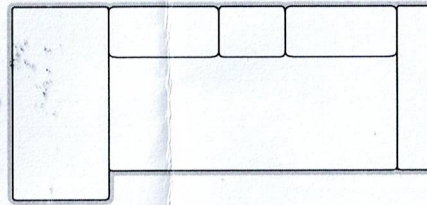

**The seat back of this product can be adjusted in 3 stages.**

Push forward from the back, and when a "click" sound is made, the recliner will be released, returning to the first stage. From that state back, you can adjust to the second and third stages.

