

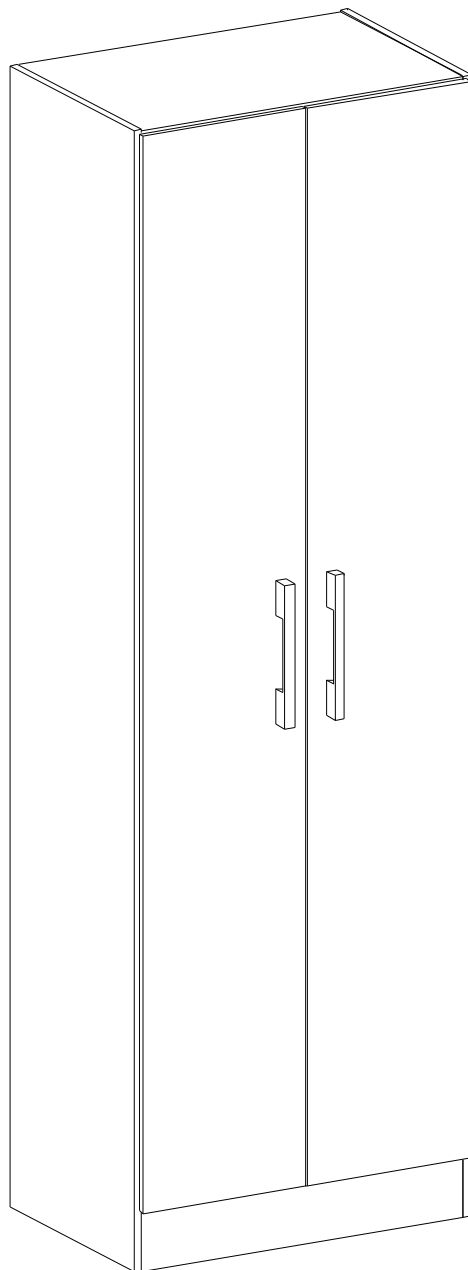

## **MANUAL DE INSTRUCCIONES**

---

**CLOSET ZAPATERO BAHAMAS  
MODELO: MB3701TT26-50-2**



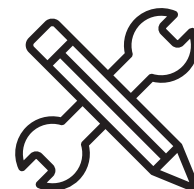

## ADVERTENCIA

Siga las instrucciones que se detallan en el manual, si presenta alguna diferencia en el contenido de sus piezas póngase en contacto con la tienda donde fue adquirido.

## RECOMENDACIONES

- Estudie atentamente las instrucciones antes del montaje.
- Ordene las piezas que componen el mueble.
- Agrupe y ordene la quincallería.
- Prepare una zona despejada para el montaje.
- Monte las piezas sin forzar los ensambles, una vez armada toda la estructura, reaprete de forma definitiva.
- Volver a apretar los tornillos después de un tiempo de uso.
- Conserve estas instrucciones de montaje.



Herramientas requeridas  
(no incluidas)



2 personas  
para el armado



Producto contenido  
en 1 cajas

# QUINCALLERÍA

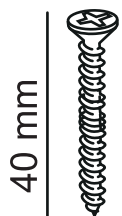

A x22



B x08



C x04



D x80



E x27



F x2

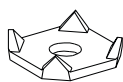

G x16



H x1

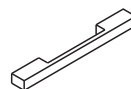

I x2

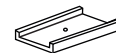

J x4

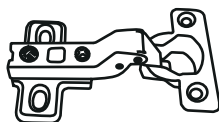

K x6

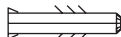

L x1

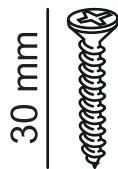

M x1



N x1



O x12

# PIEZAS



01 x1

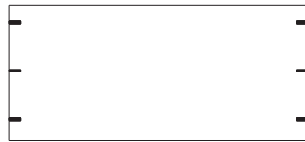

02 x1

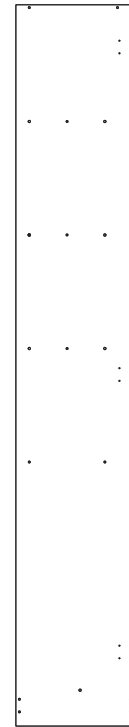

33x1

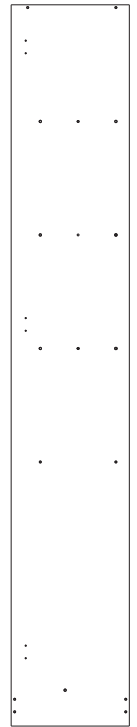

34 x1



05 x3

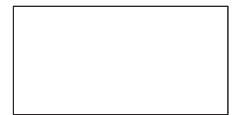

10 x5

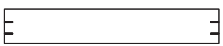

07 x1



08 x1

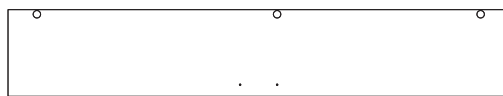

06 x2

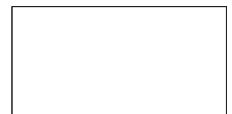

09 x1

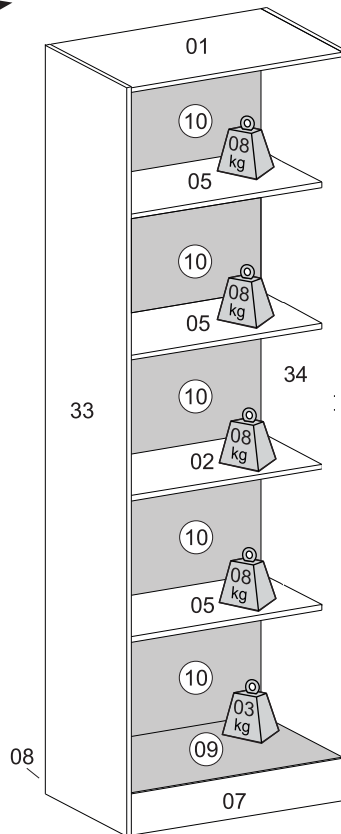
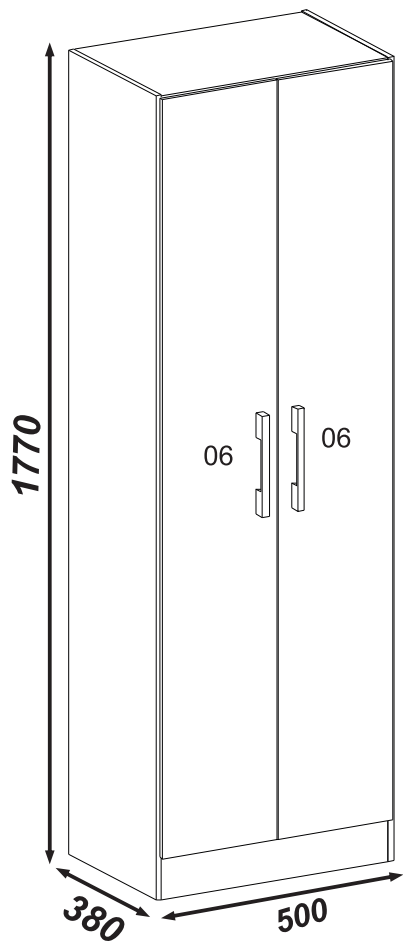

# PASO 1

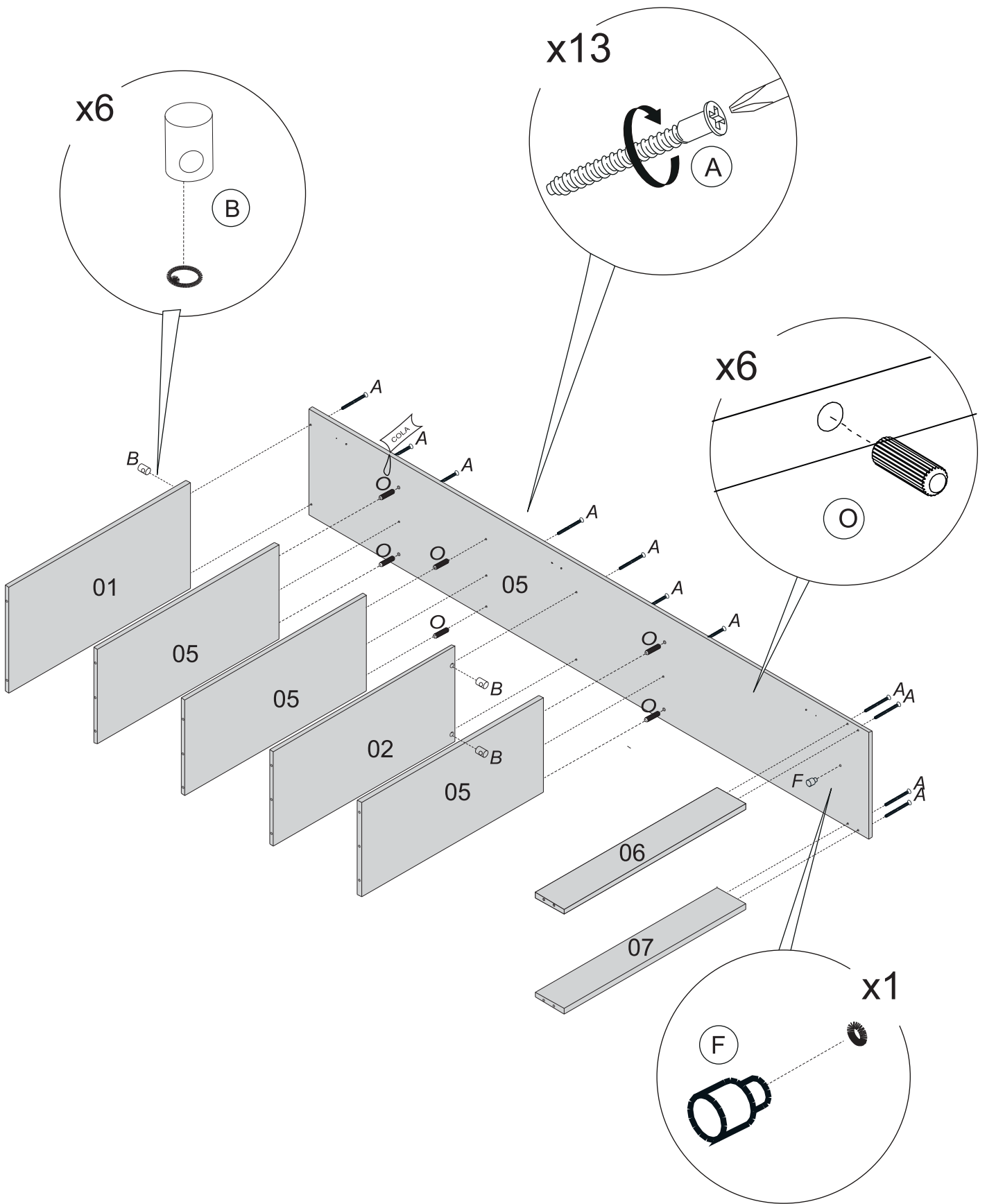

## PASO 2

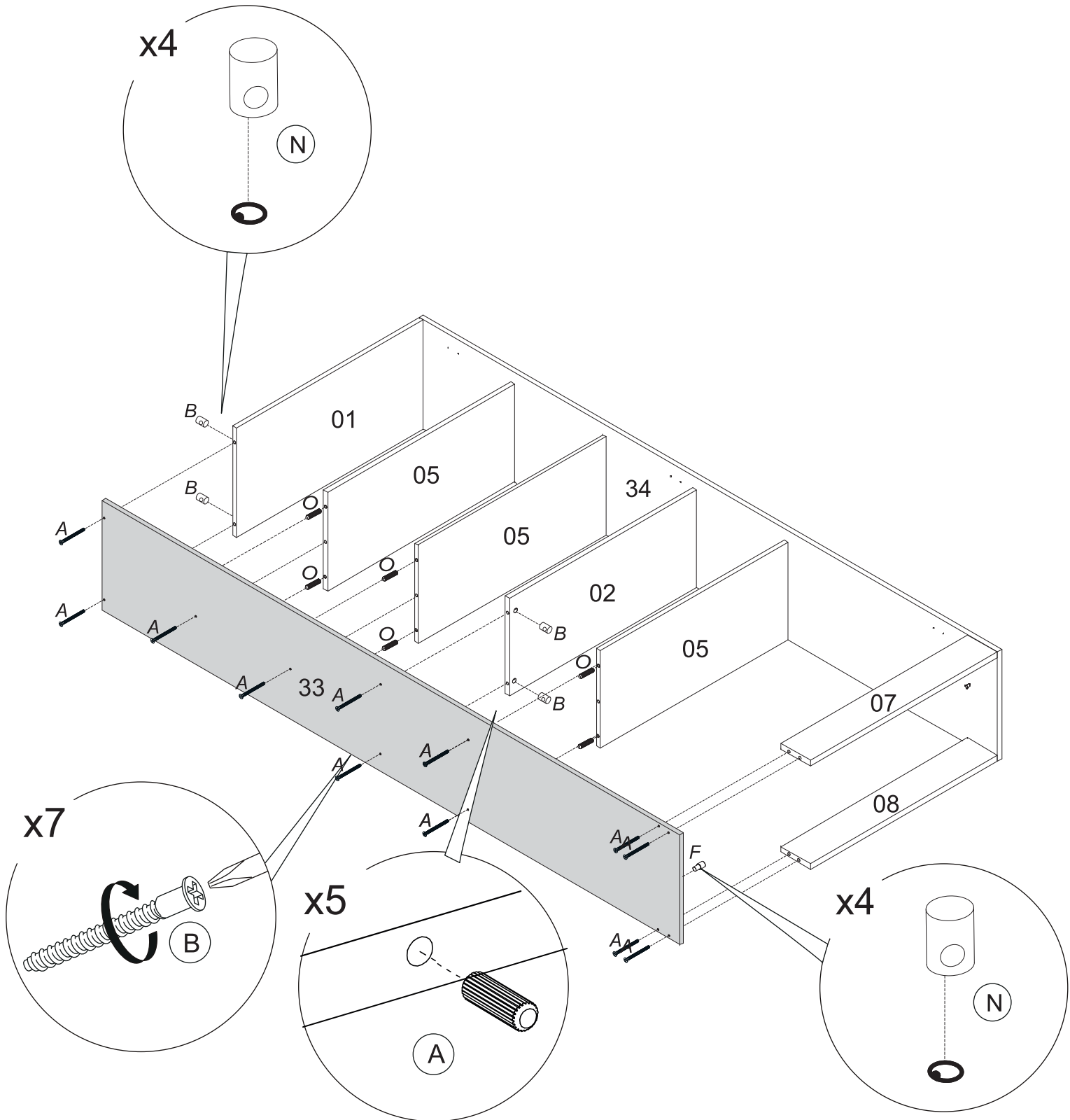

### PASO 3

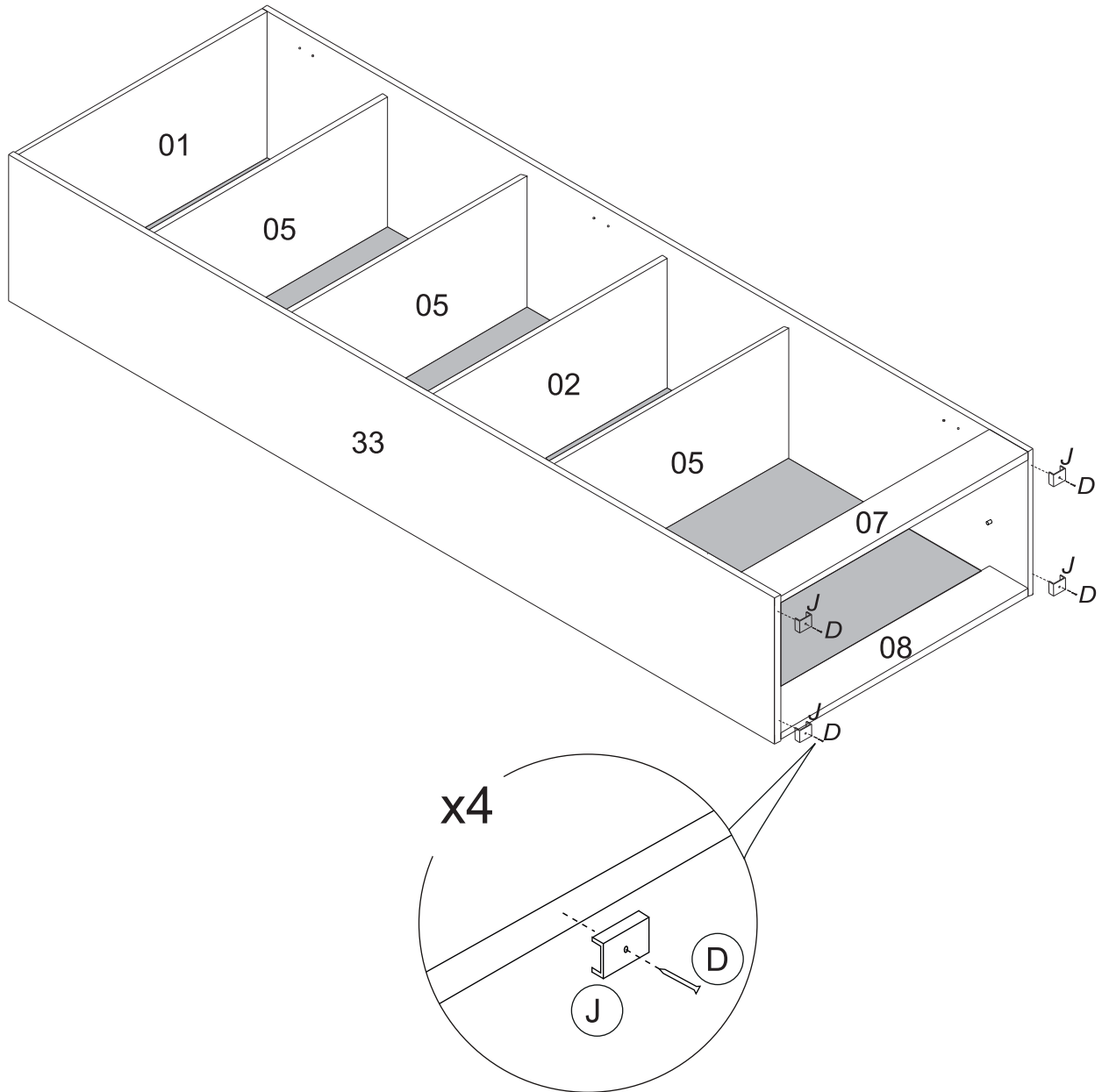

Poner las protecciones inferiores  
como indica la imagen.

# PASO 4

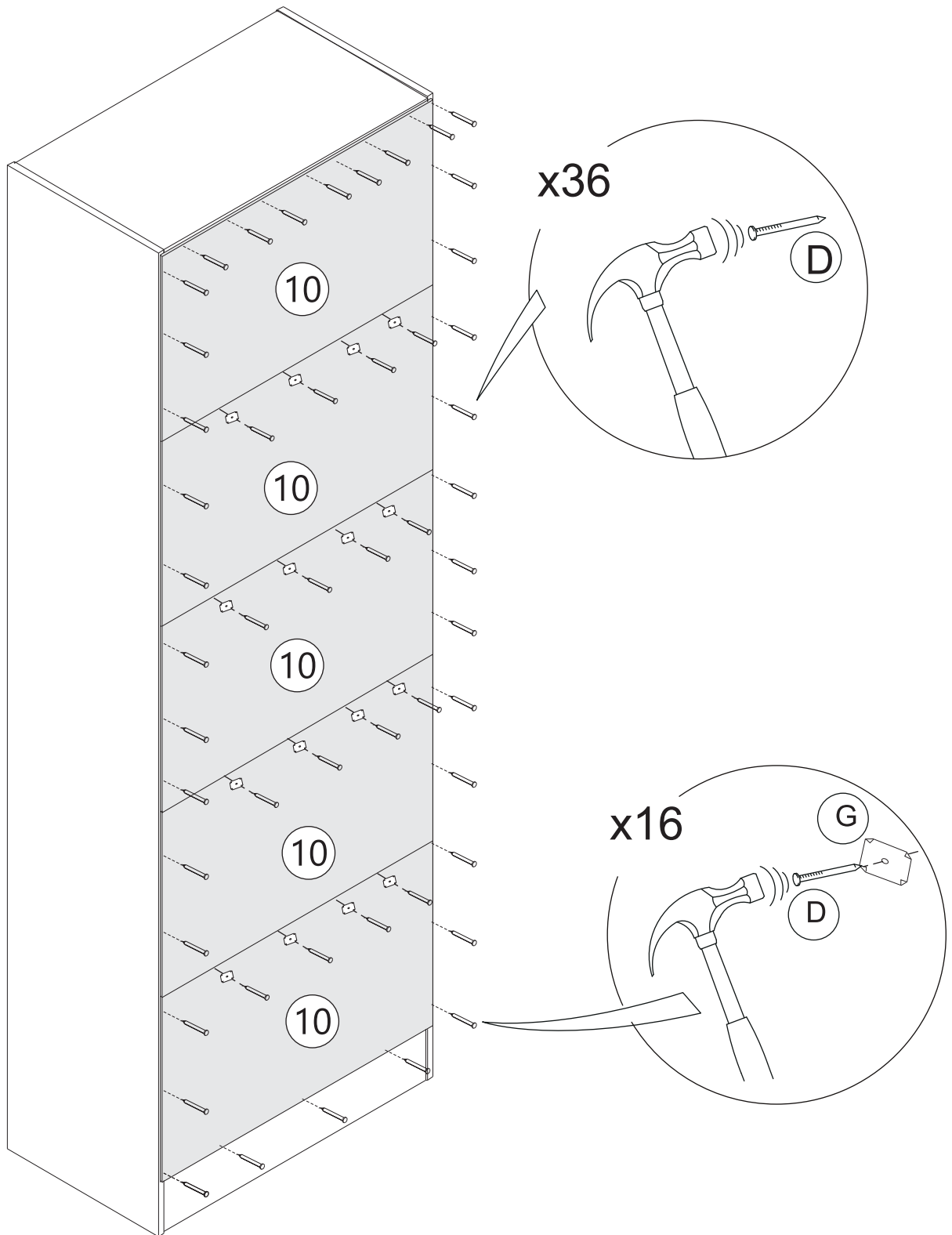

**PASO 5**

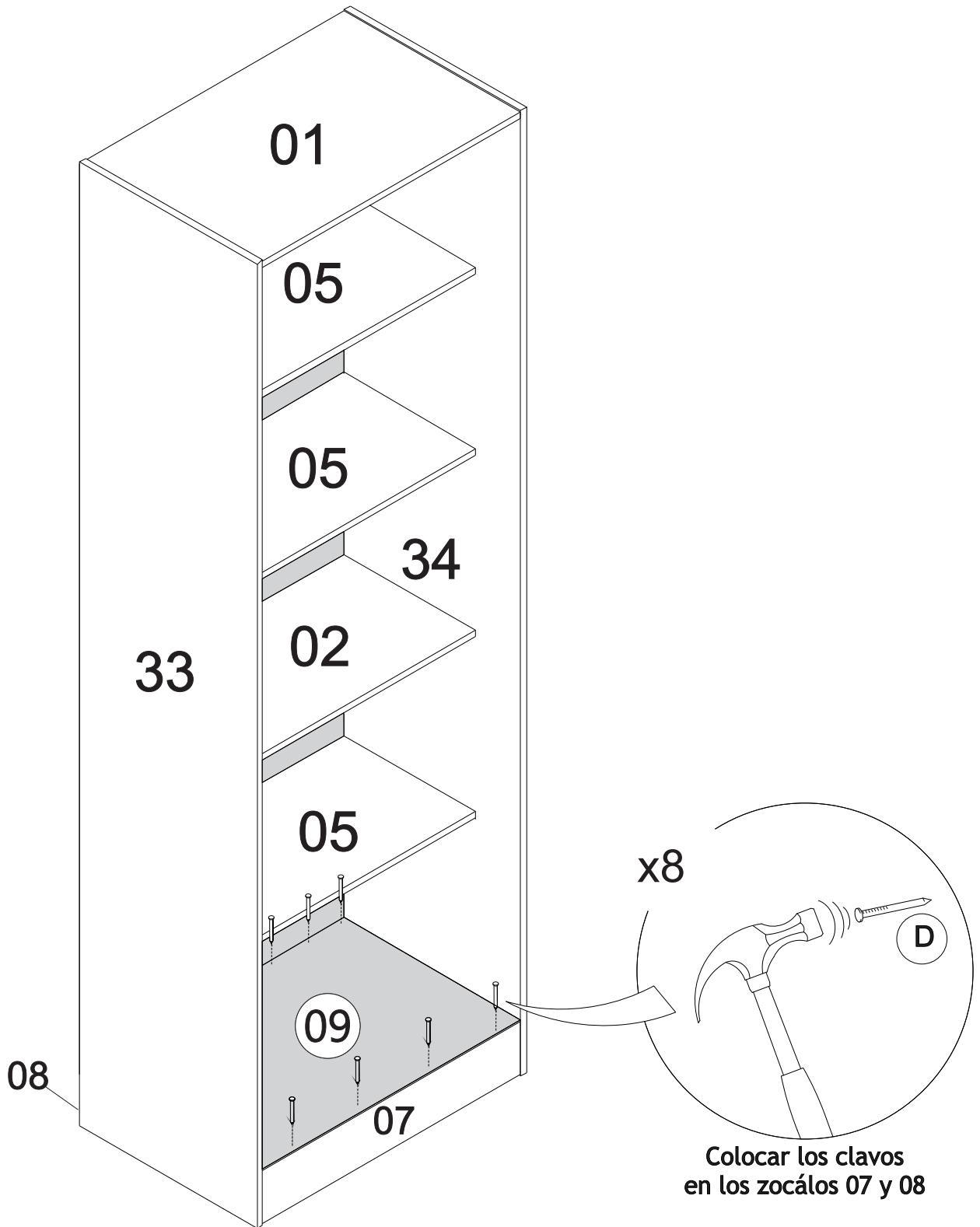

## PASO 6

Montaje de las bisagras en las puerta (06) Poner la base y bisagra.

Instale las bisagras en las puertas, sobre una superficie plana y protegida (con frazadas o cartones).

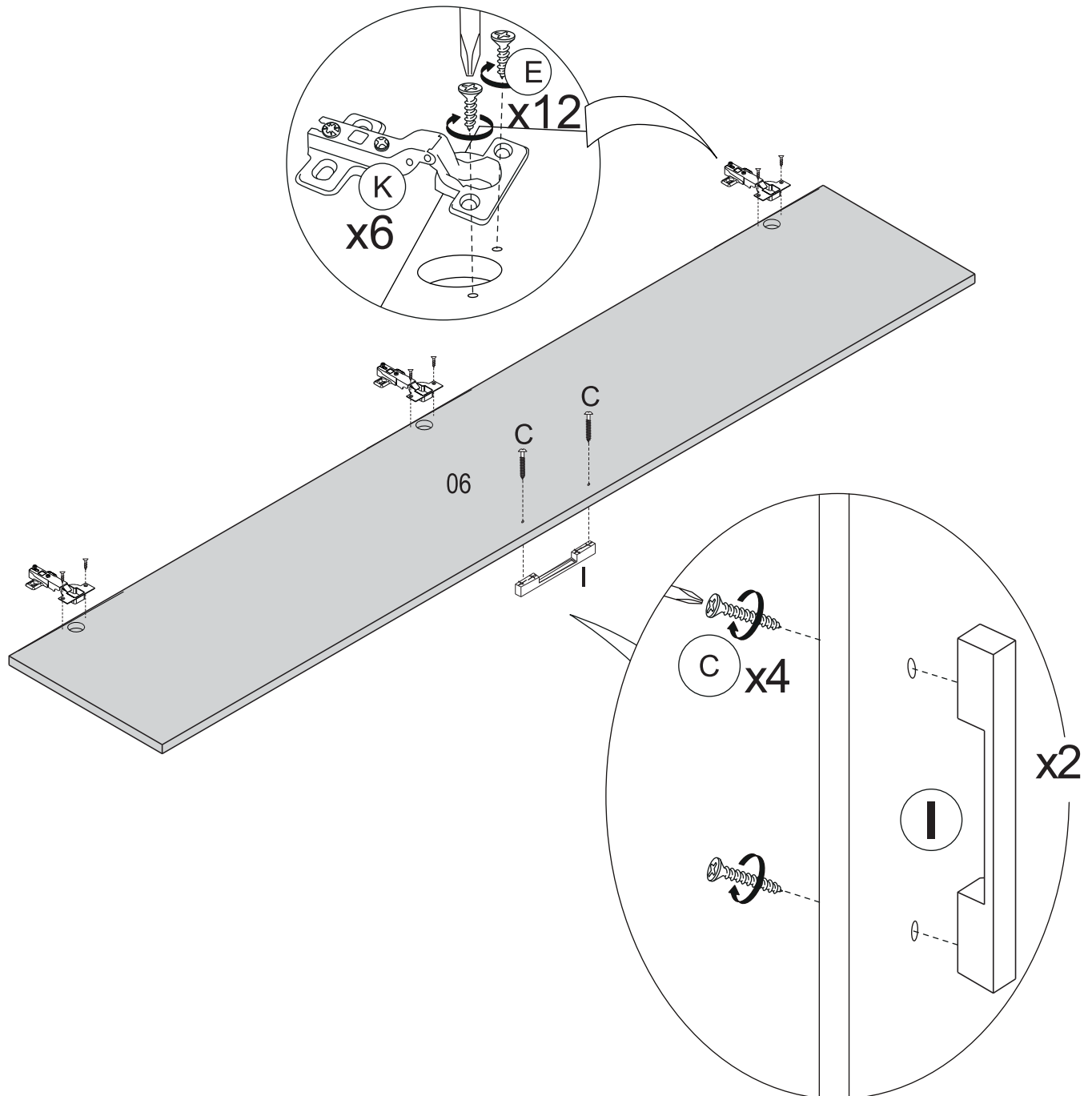

**PASO 7**

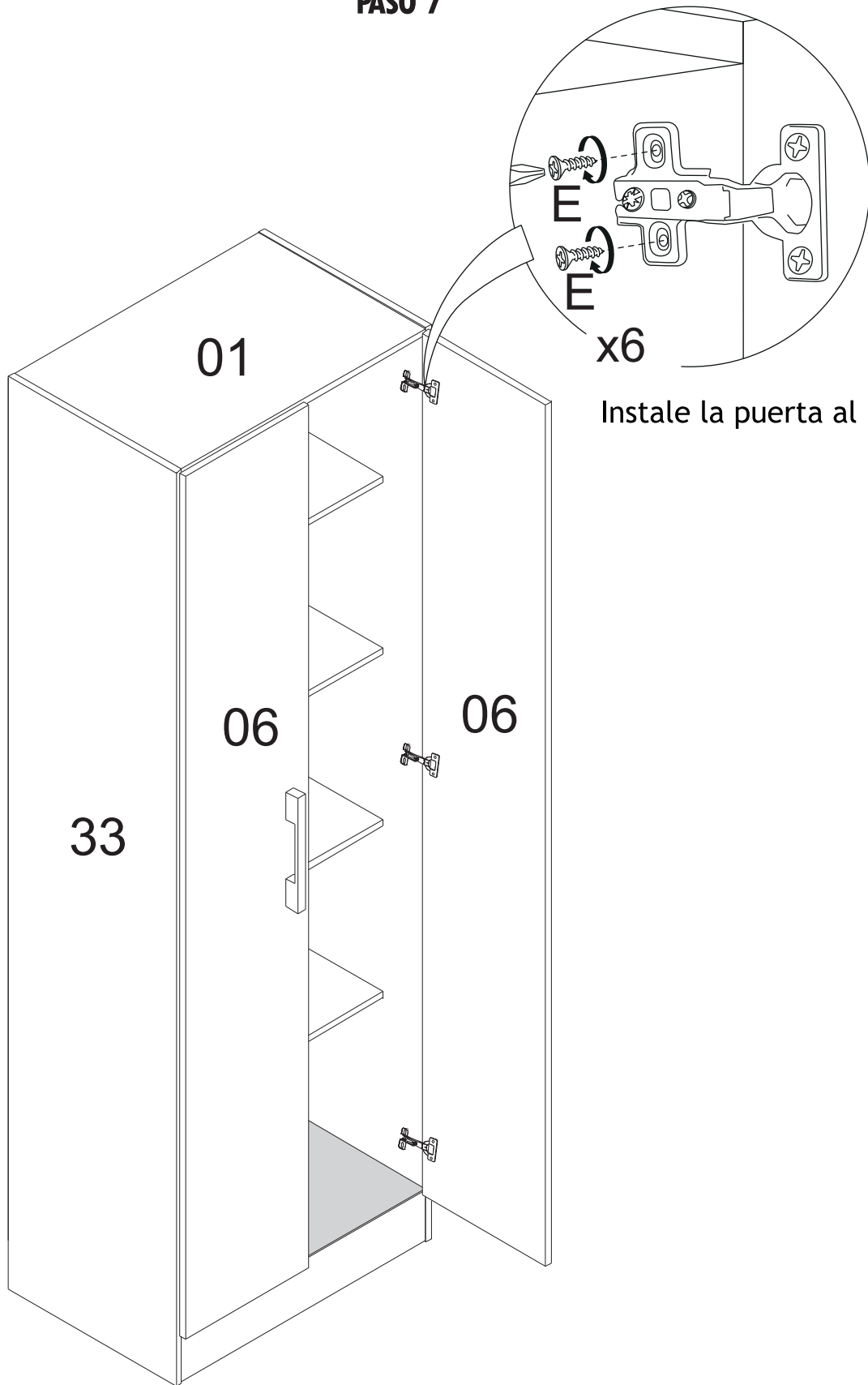

Instale la puerta al mueble.

## PASO 8

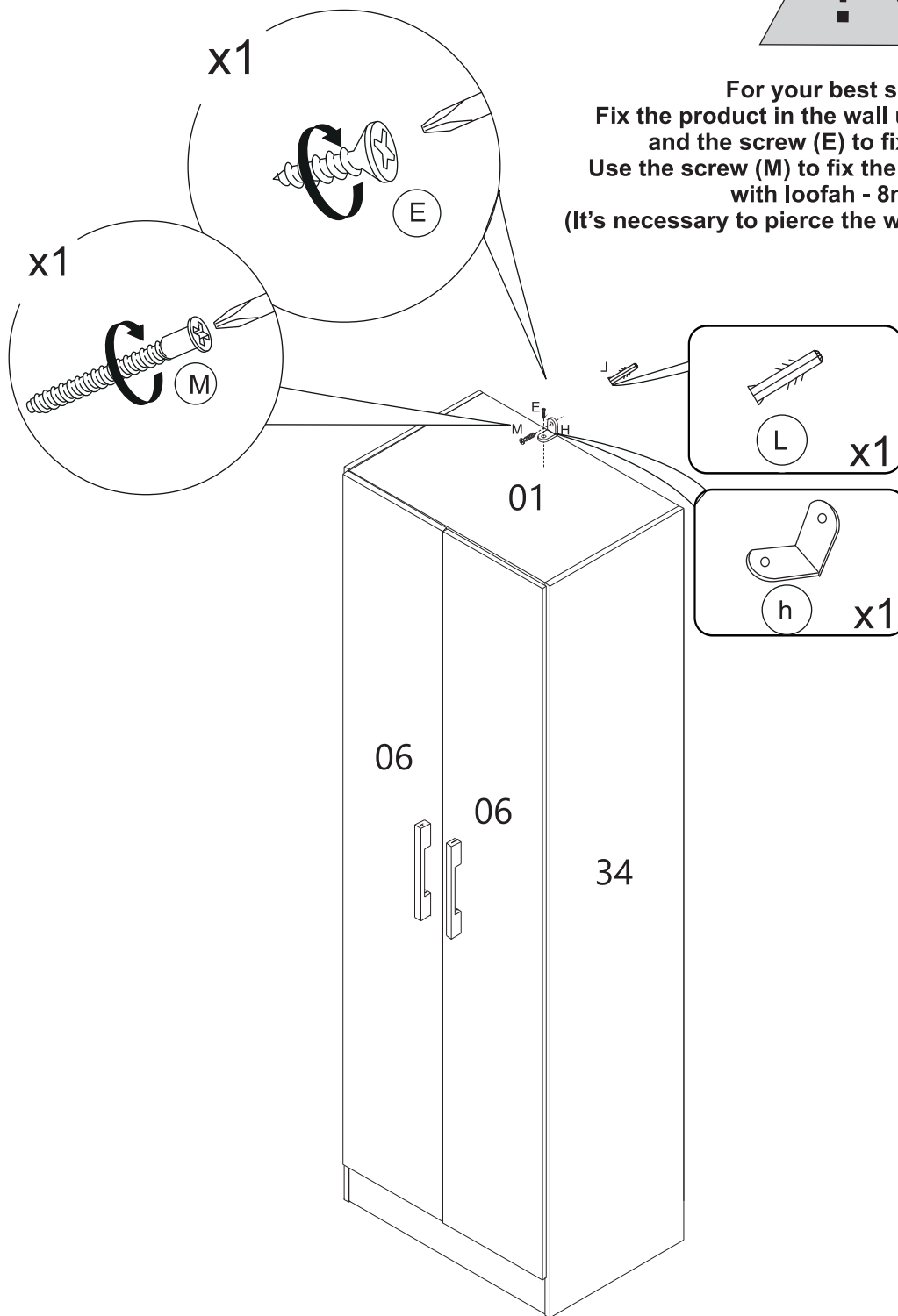
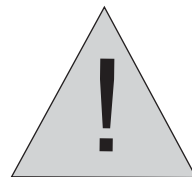

**For your best security**  
Fix the product in the wall using the angle (h)  
and the screw (E) to fix the product.  
Use the screw (M) to fix the product in the wall  
with loofah - 8mm (L)  
(It's necessary to pierce the wall to fix the product)



## **TODOS JUNTOS**

Entre todos sí es posible  
lograr un impacto real  
ahorrando papel.

