



mxmóveis

Rodovia SC-492 - Km 10 - B. Industrial  
89905-000 - Bandeirante - SC  
Fone: (49) 3622-4549  
e-mail: mxmoveis@mxmoveis.com.br

Ref. Mu019

## Multiuso Armário Cabinet

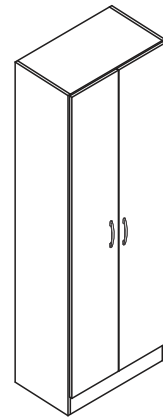
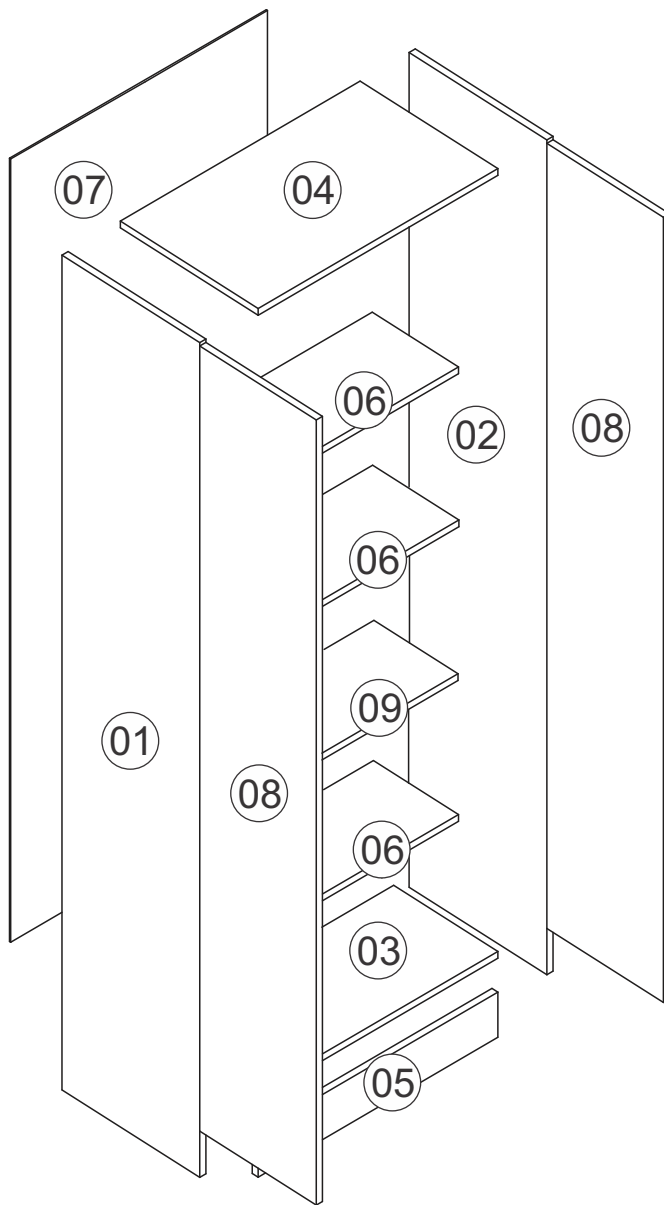

Nº	CÓDIGO CODE ASSISTÊNCIA ATTENDANCE	NOME DA PEÇA/DESCRIPCIÓN PIEZAS/DESCRIPTION PARTS	MEDIDAS (mm) MEASURES (mm)	QTD.	BRANCO NEVE BRANCO NEVE	MARROCOS MARROCOS
01	MU019.18.00	Lateral externa esquerda/Lateral izquierda	1700X270X12	01	306355	306338
02	MU019.17.00	Lateral externa direita/Lateral derecha	1700X270X12	01	306354	306337
03	MU019.01.00	Base Inferior/Base	438X270X12	01	306351	306334
04	MU019.05.00	Base superior/Base superior	438X270X12	01	306353	306336
05	MU019.30.00	Rodapé/Zócalo	438X45X12	01	306374	306373
06	MU019.27.00	Prateleira/Repisa	438X250X9	03	306293	306293
07	MU019.13.00	Forro/Revês	1643X450X2,5	01	306289	306289
08	MU019.25.00	Porta/Puerta	1639X221X12	02	306356	306339
09	MU019.02.00	Base interna/Base	438x270x12	01	306352	306335

# Ferragens/Herrajes

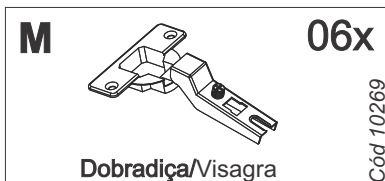
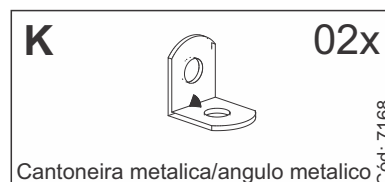
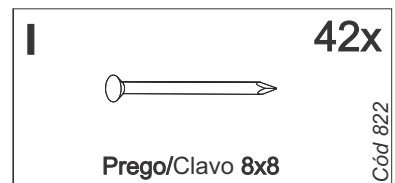
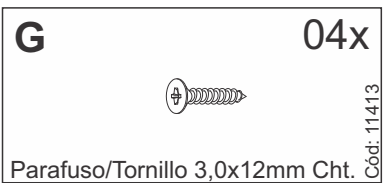
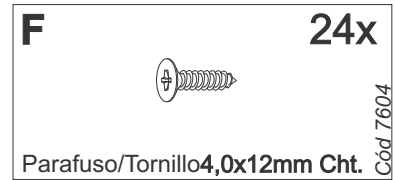
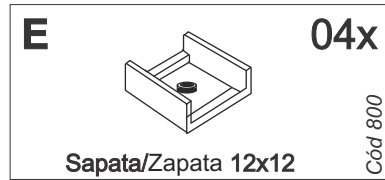
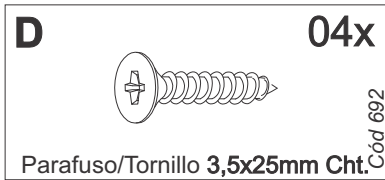
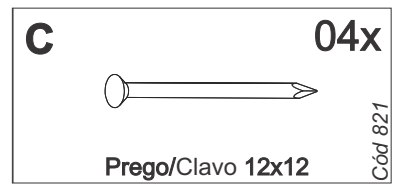
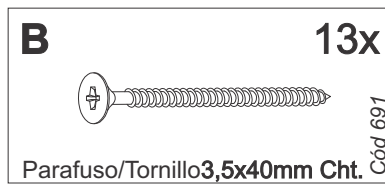
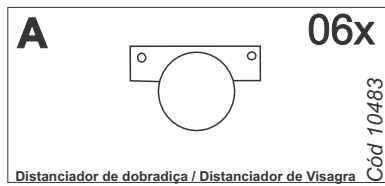

IMPORTANTE: Utilize a régua para medir a ferragem.



Medidas em mm

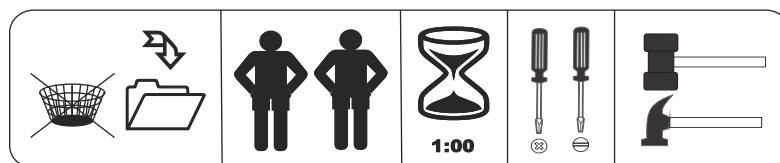

# Pré-Montagem/Preparación Piezas

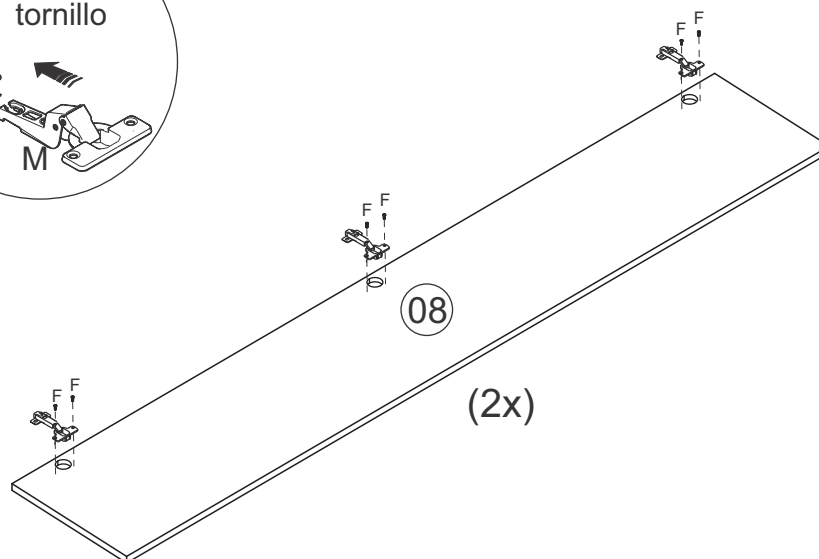
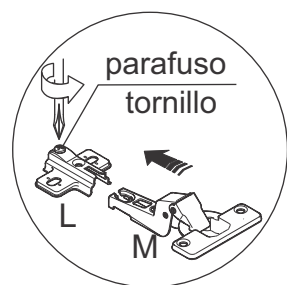
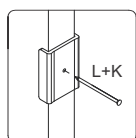
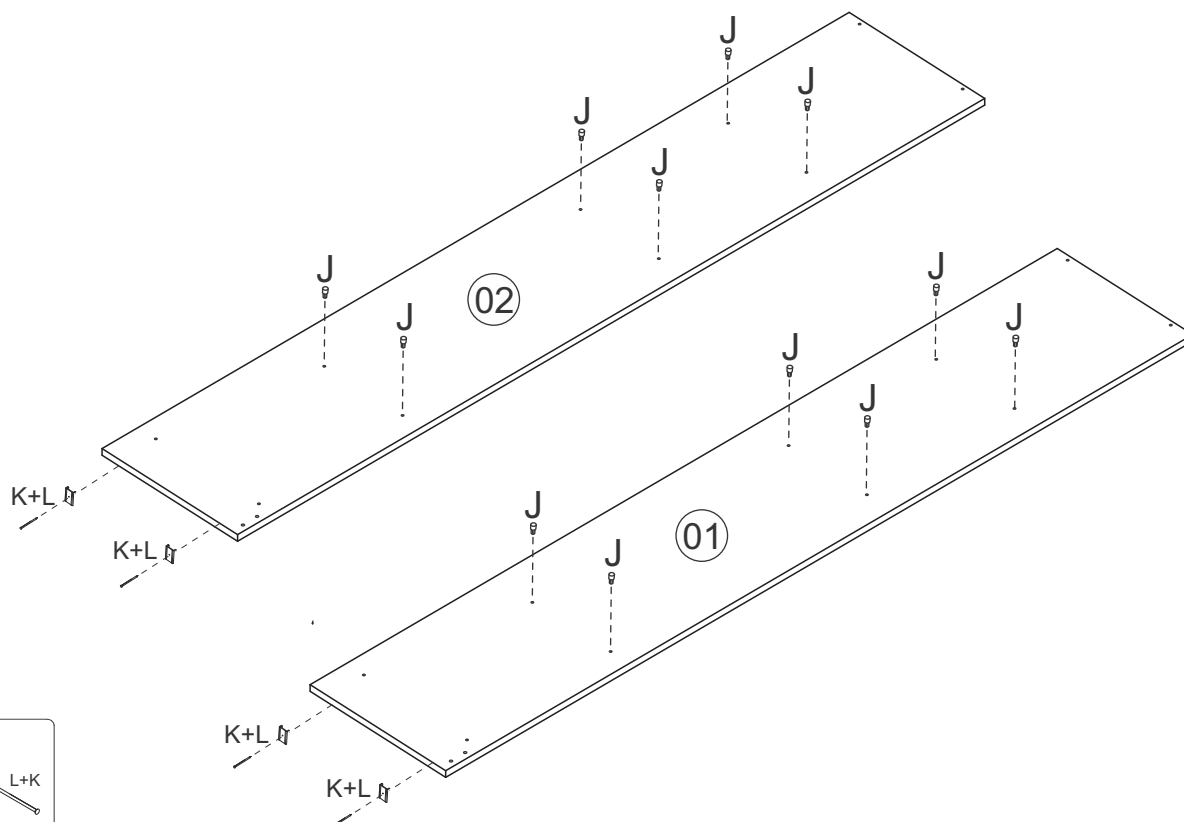

## 01 Montagem/Montaje

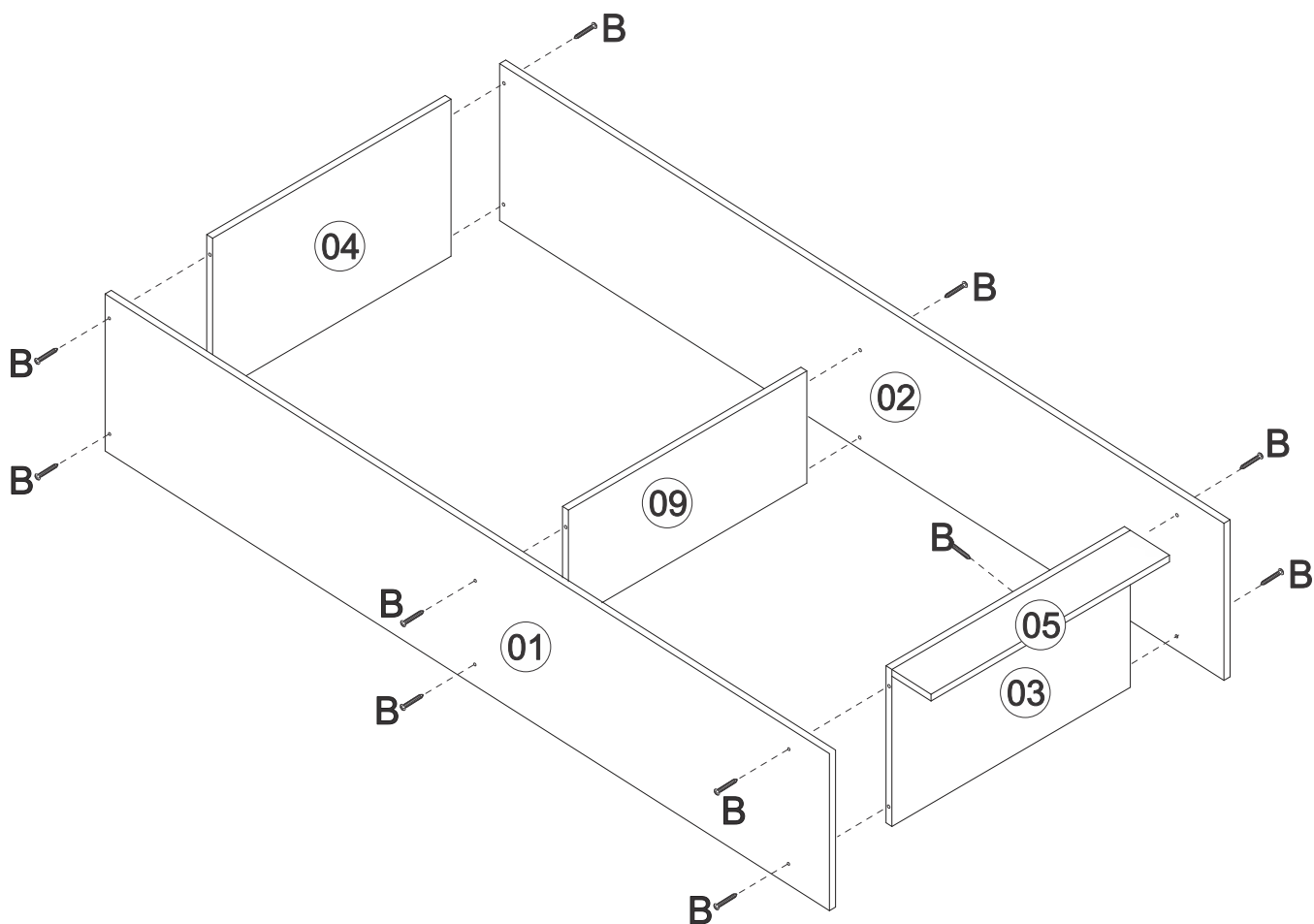

## 02 Montagem/Montaje

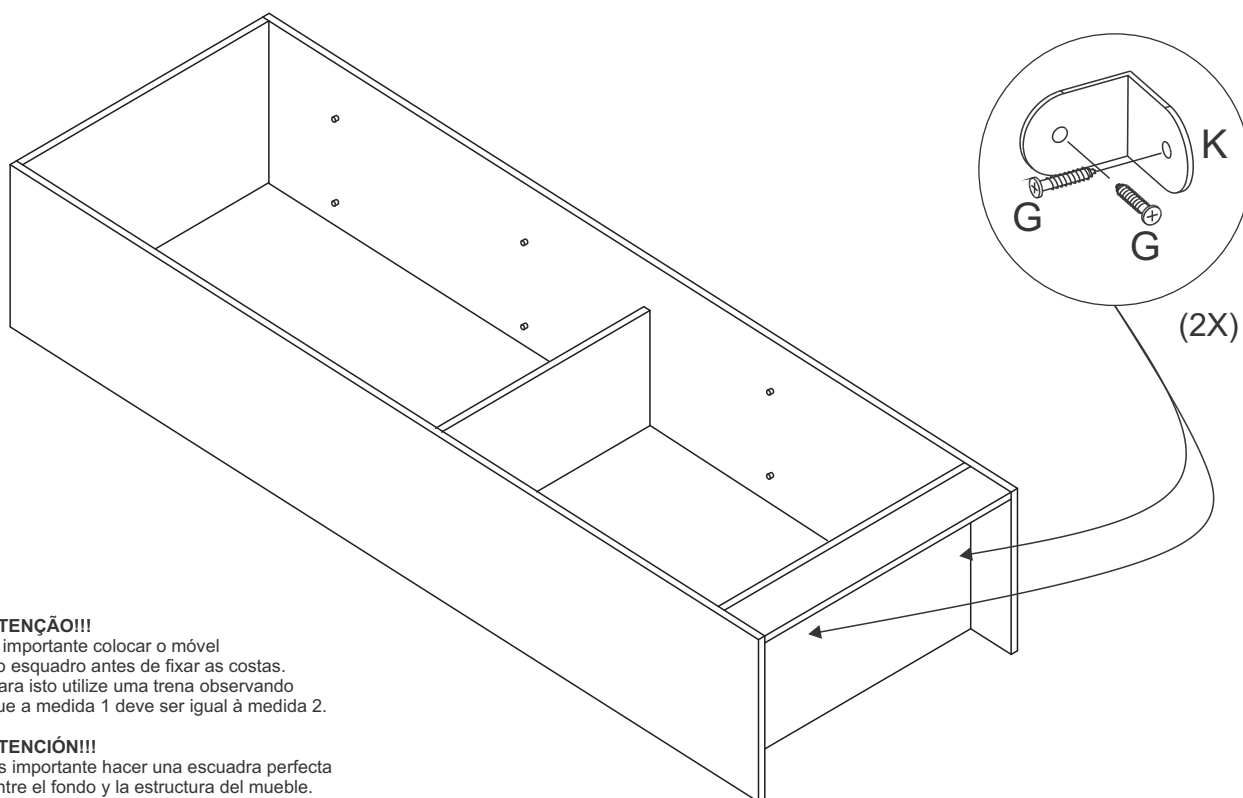

### ATENÇÃO!!!

É importante colocar o móvel no esquadro antes de fixar as costas. Para isto utilize uma trena observando que a medida 1 deve ser igual à medida 2.

### ATENCIÓN!!!

Es importante hacer una escuadra perfecta entre el fondo y la estructura del mueble. Observe que la medida 1 debe ser la misma que la medida 2.

### 03 Montagem/Montaje

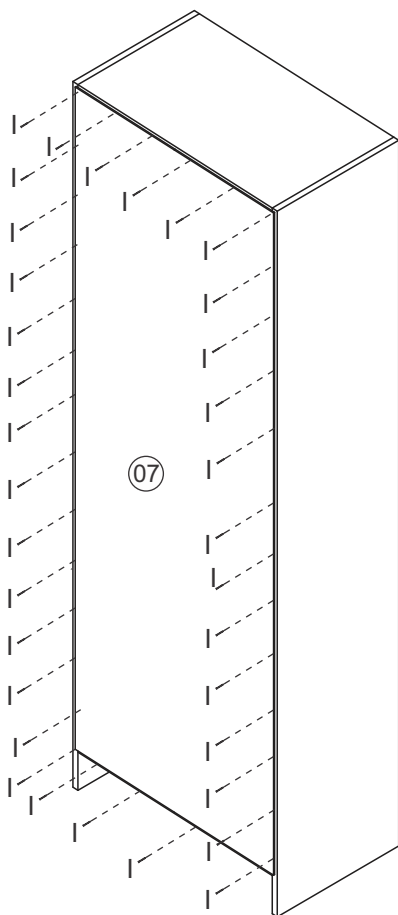

#### ATENÇÃO!!!

É importante colocar o móvel no esquadro antes de fixar as costas. Para isto utilize uma trena observando que a medida 1 deve ser igual à medida 2.

#### ATENCIÓN!!!

Es importante hacer una escuadra perfecta entre el fondo y la estructura del mueble. Observe que la medida 1 debe ser la misma que la medida 2.

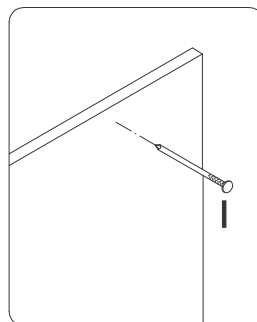

\*Colocar um prego (I) a cada 100mm

### 04 Montagem/Montaje

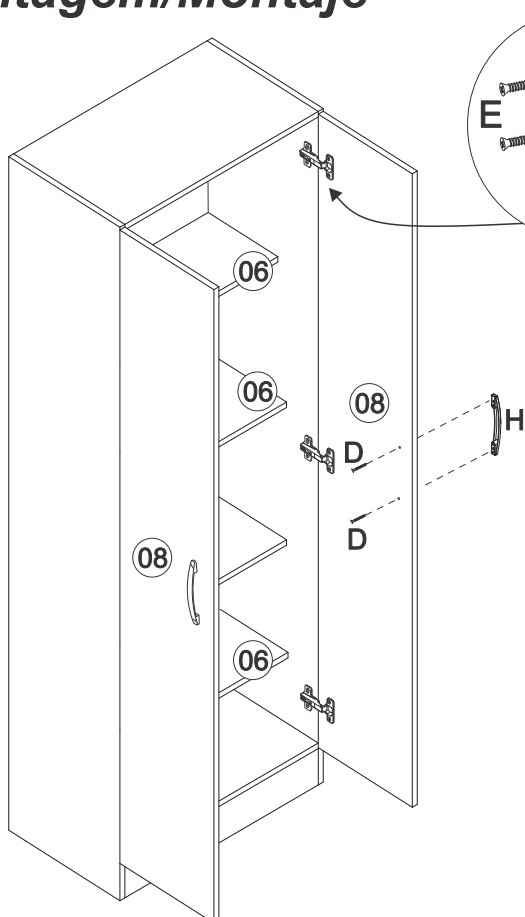

**Obs:** os calços plásticos são adicionados as dobradiças, antes da sua fixação.

**Nota:** los calzos plasticos son colocados antes que la visagra en la puerta.

**Limpeza/Limpieza**

- ☞ Use um pano levemente umedecido com água, seguido de pano seco.
- ☞ *Use solamente un paño húmedo con agua y después un paño seco.*
- ☞ Nunca utilize produtos químicos ou abrasivos.
- ☞ *No utilice productos quimicos o abrasivos.*