

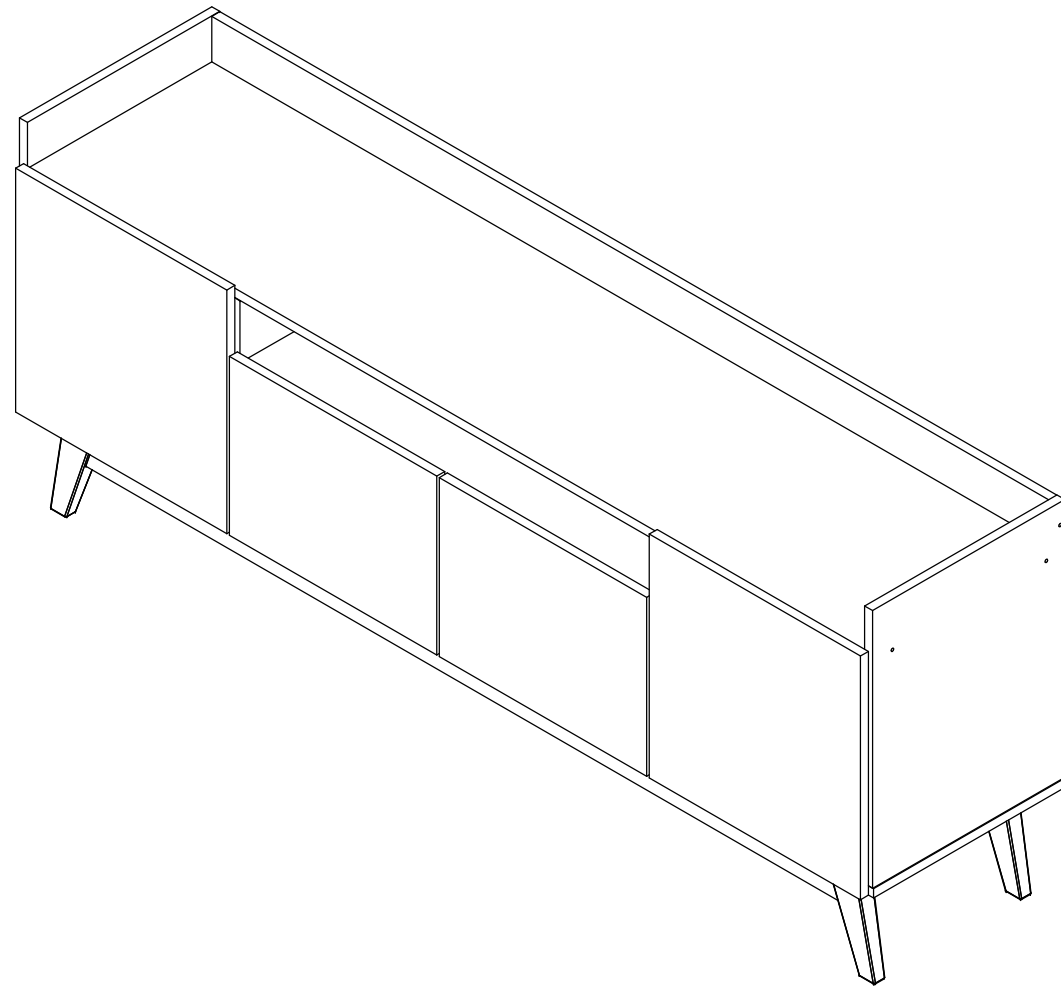







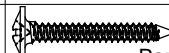

Rack Florença

Instruções de Montagem Assembly Instructions / Instrucciones de Montaje

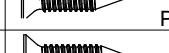
01

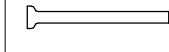

Lista de ferragens Hardware list

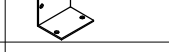
REF	Lista de materiais	QNT
A	 Cavilha 6 x 30	20
B	 Parafuso Flange 3,5x40	21
C	 Parafuso chato 3,5x14	65
D	 Parafuso chato 3,5x20	24
E	 Prego 10 x 10	40
F	 Dobradiça	08
G	 Pé	06
H	 Cantoneira	06
I	 Cantoneira 20x20	04
J	 Garra p/ Costa	06

Lista de peças / Parts lists / Lista de piezas

Nº	Descrição	Dimensão	Quant
01	Lateral Esq/Lado Izquierdo	450x360x15	1
02	Lateral Dir/Lado Derecho	450x360x15	1
03	Tampo/Cubrir	1567x360x15	1
04	Base/Base	1600x360x15	1
05	Porta/Puerta	395x395x15	2
06	Porta Menor/Puerta más Pequeña	388x290x15	2
07	Divisão Esquerda/División Izquierda	360x360x15	1
08	Divisão Direita/División Correcta	360x360x15	1
09	Prateleira/Estante	771x360x15	1
10	Travessa Superior/Travesaño Superior	1567x74x15	1
11	Travessa Inferior/Travesaño Inferior	1474x70x15	2
12	Costa Lateral/Costa Lateral	402x384x03	2
13	Costa Central/Costa Central	786x268x03	1

Ferramentas Necessárias Herramientas Necesarias

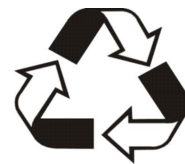
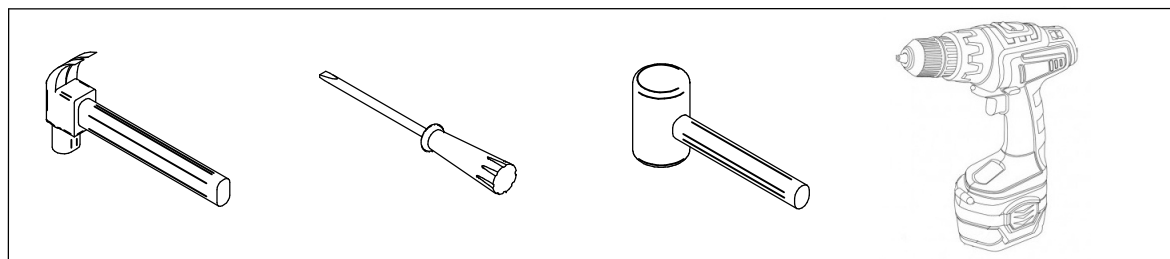

Antes de montar seu móvel, leia cuidadosamente o Manual de Instruções e o mantenha para futuras consultas.

OBRIGADO.

Antes de montar sus muebles, lea cuidadosamente el Manual de instrucciones y guárdelo para futuras referencias.

GRACIAS

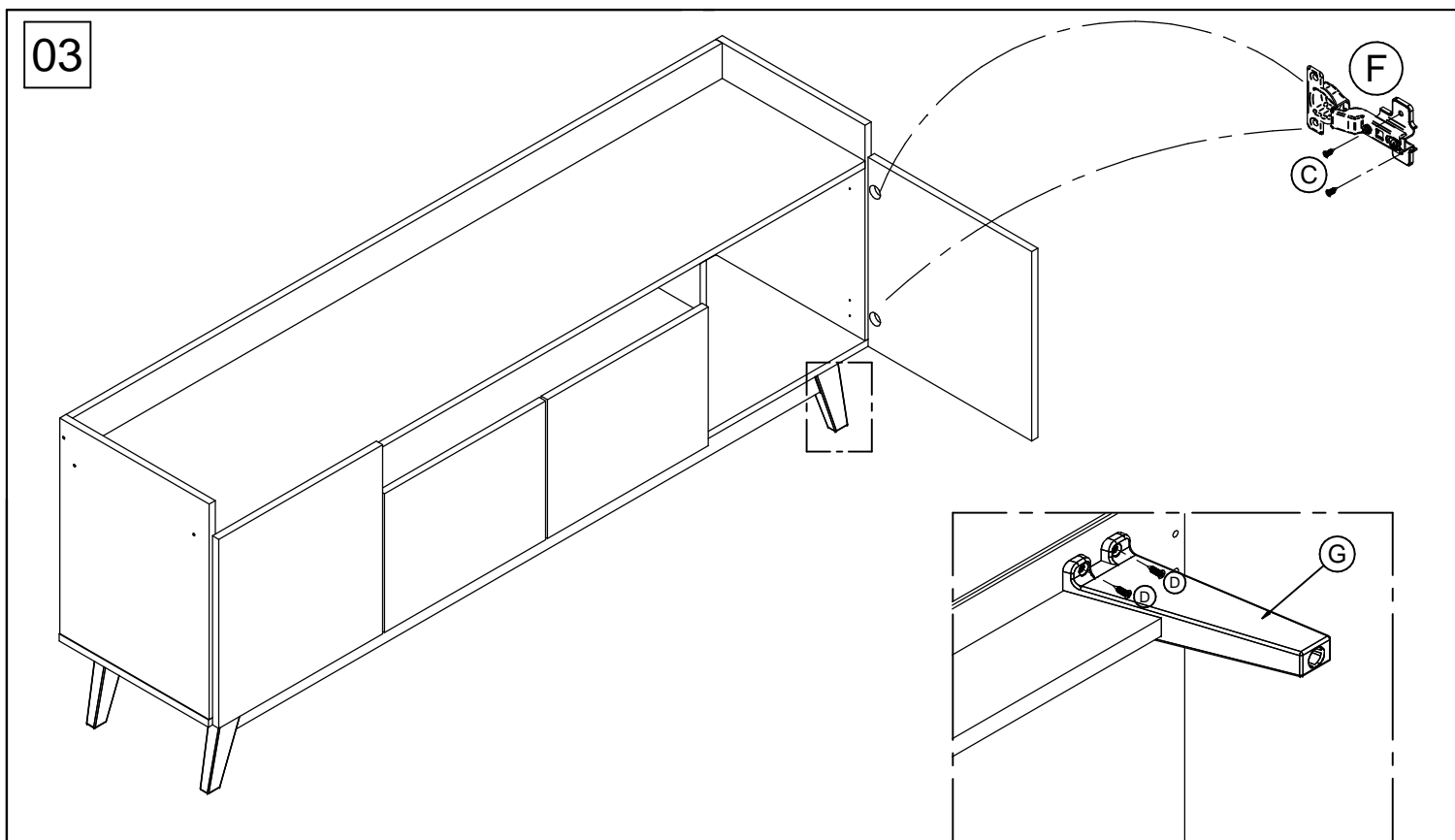
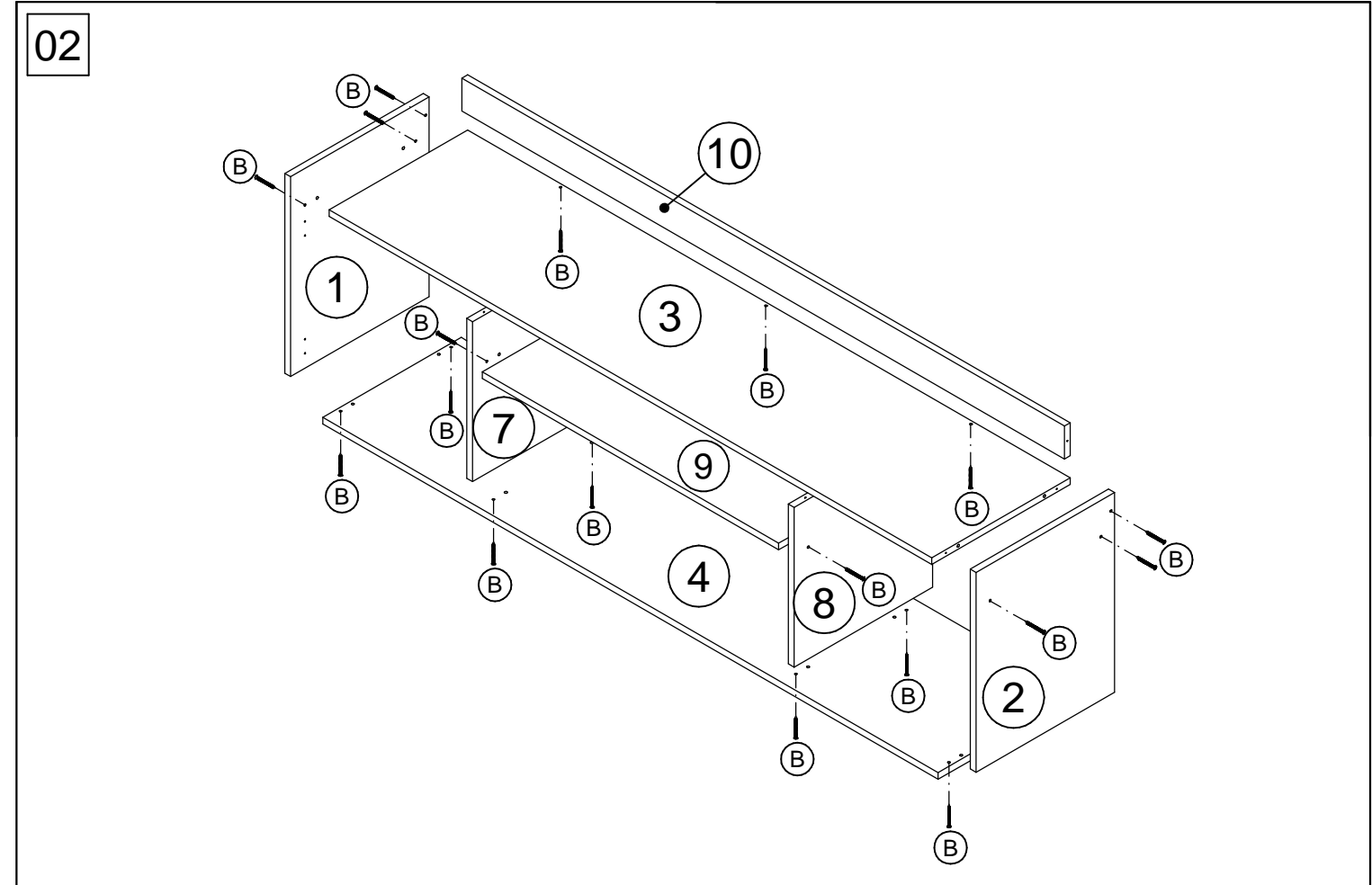
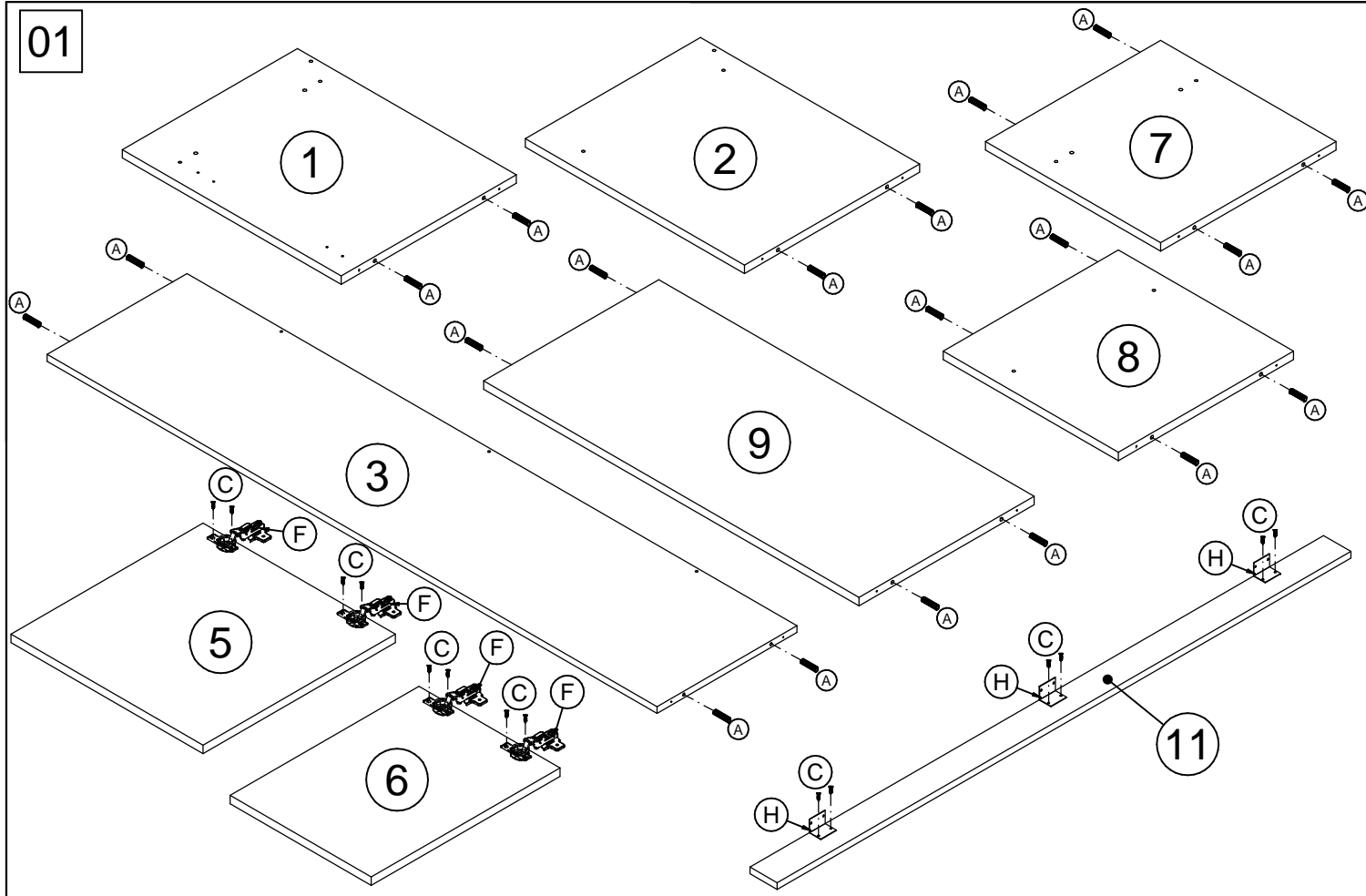

Utilizar 4 parafusos (D) para fixar os pés (G).
Utilice 4 tornillos (D) para fijar los pies (G).

