

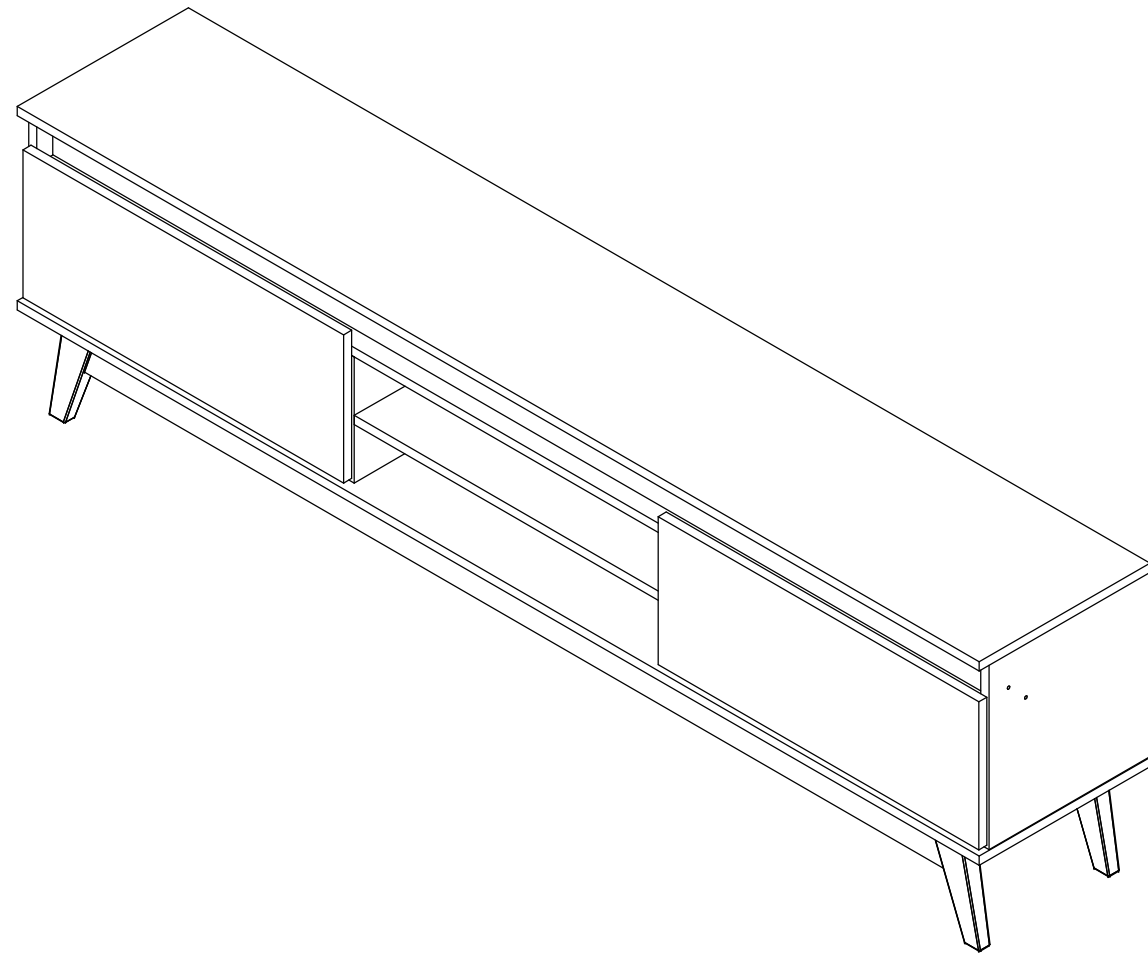









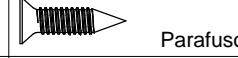

Rack Texas

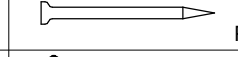
Instruções de Montagem Assembly Instructions / Instrucciones de Montaje

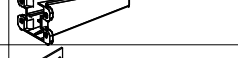
01



Lista de ferragens Hardware list

REF	Lista de materiais	QNT
A	 Cavilha 6 x 30	22
B	 Parafuso Flange 3,5x40	18
C	 Parafuso chato 3,5x14	46
D	 Parafuso Flange 3,5x20	28
E	 Prego 10 x 10	40
F	 Dobradiça	04
G	 Pé	06
H	 Cantoneira	06
I	 Cantoneira Fixação 20x20	06
J	 Parafuso Maq. M4x25	08
K	 Porca Sextavada	08
L	 Limitador de Porta	02

Lista de peças / Parts lists / Lista de piezas

Nº	Descrição	Dimensão	Quant
01	Lat Esq/Lado Izquierdo	300x300x15	01
02	Lat Dir/Lado Derecho	300x300x15	01
03	Base/Base	1800x320x15	01
04	Tampo/Cubrir	1800x320x15	01
05	Divisão/División	204x300x15	02
06	Porta/Puerta	600x240x15	02
07	Travessa Frontal/Travesaño Delantero	1567x80x15	01
08	Travessa Inferior/Travesaño Inferior	1567x70x15	02
09	Costa/Costa	1790x324x03	01
10	Travessa/Travesaño	1767x80x15	01
11	Prateleira/Estante	579x300x15	01

Ferramentas Necessárias Herramientas Necesarias

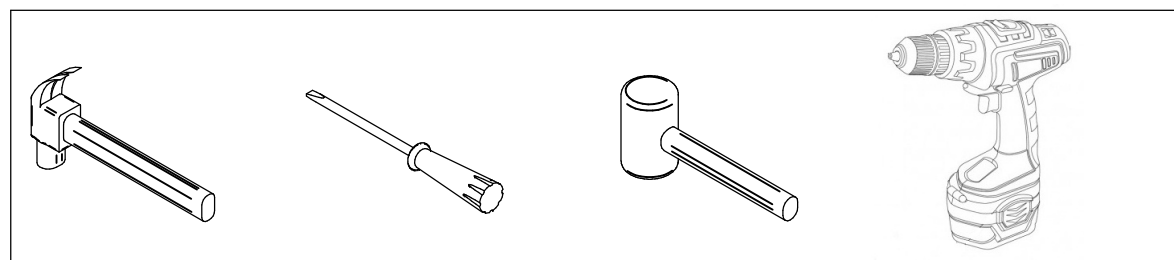

Antes de montar seu móvel, leia cuidadosamente o Manual de Instruções e o mantenha para futuras consultas.

OBRIGADO.

Antes de pegar el móvil, por favor lea el manual de instrucciones y consérvelo para consultas futuras.

