

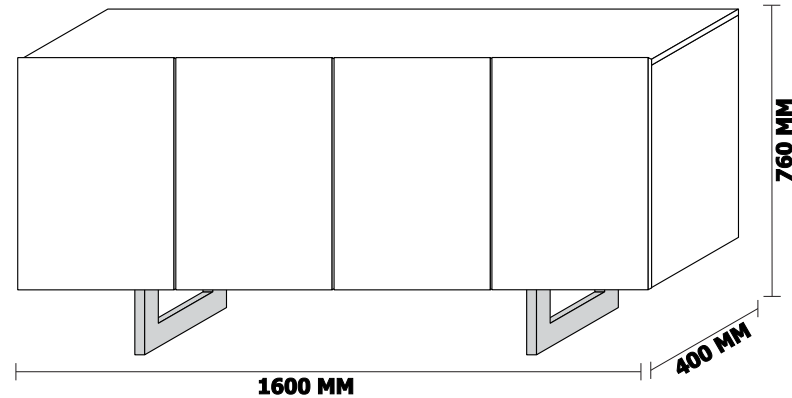

Nova linha, mesma qualidade.



Manual de montagem

Caro montador !!!

Para uma melhor montagem de nosso produto siga as seguintes instruções:

- Retire todas as peças da caixa e identifique-as;
- Separe e confira todos os acessórios;
- Deixe as peças em pé, nunca as deite colocando umas sobre as outras;
- Utilize a própria embalagem como tapete para a montagem;

Assembly instructions

Dear Assembler !!!

For a better assembly of our products follow the instructions below:

- Remove all parts from the box and identify them;
- Separate and check all accessories;
- Leave the pieces upright, never lay them on top of each other;
- Use the packaging itself as a carpet for assembly;

Instrucciones de montaje

Estimado Armador !!!











Para un mejor montaje de nuestros productos sigue las instrucciones de abajo:

- Saque todas las piezas de la caja e identifíquelas;
- Separe y revise todos los accesorios;
- Deje las piezas en posición vertical, nunca las coloque una encima de la otra;
- Utilizar el propio embalaje como alfombra para el montaje.

Acessórios

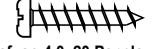
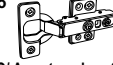
Accessories

Accesorios

A	Cod. 0050  Castanha Girofix - 20un	B	Cod. 0051  Pino Girofix - 20un	C	Cod. 0053  Cavilha 8x30 madeira - 20un	D	Cod. 1072  Junção de Fundo - 10un	E	Cod. 0082  Paraf. 3,5x12mm Flang. - 48un	F	Cod. 0095  Paraf. 5,0x60mm Estrutural - 17un
G	Cod. 0089  Parafuso 4,0x20 Painela - 16un	H	Cod. 1735  Dobradiça C/ Amortecedor - 08un	I	Cod. 0098  Prego 10 x 10 - 60un	J	Cod. 0533  Tampa Plástica p/ Girofix - 06un	K	Cod. 0195  Tapa Furo Plástico - 02un	L	Cod. 0199  Tapa Furo Adesivo 13mm - 06un

Ferramentas utilizadas para a montagem

Tools used for assembly

Herramientas utilizadas para el montaje

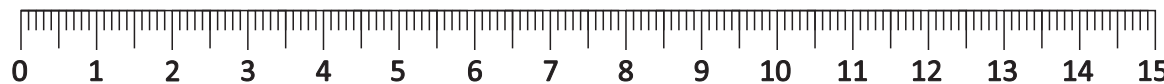
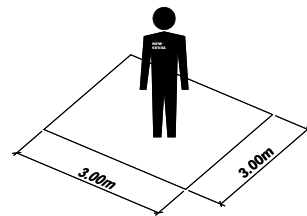

Av. Arvelino Durante, 1700 - Parque Industrial III - Sabáudia - Paraná - Brasil - Fone/Fax: (43) 3151-1740 - CEP: 86720-000

1 Passo
Step
Paso

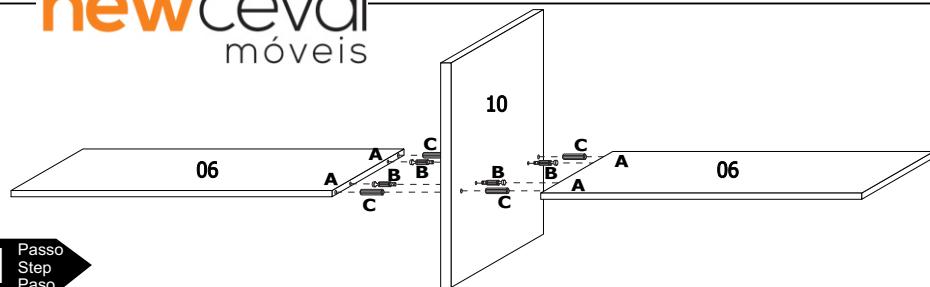

2 Passo
Step
Paso

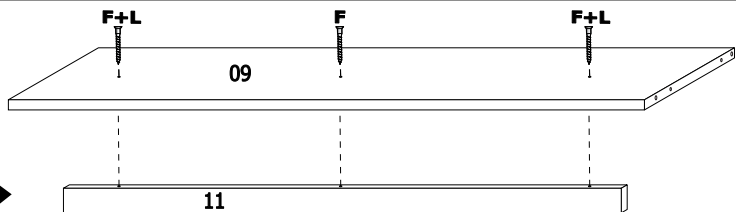

3 Passo
Step
Paso

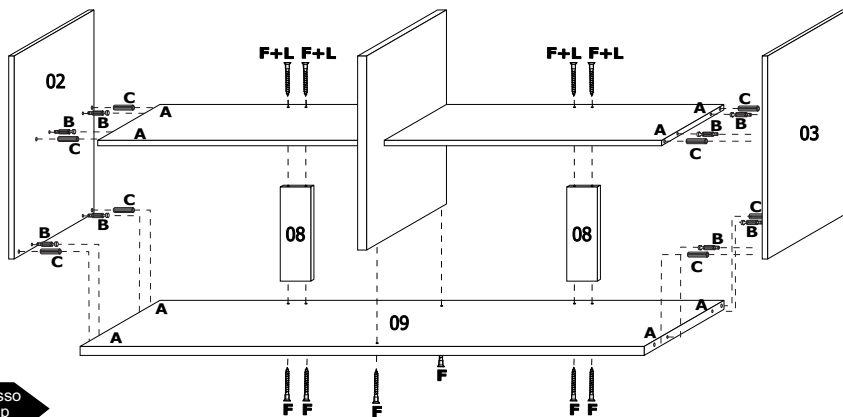

4 Passo
Step
Paso

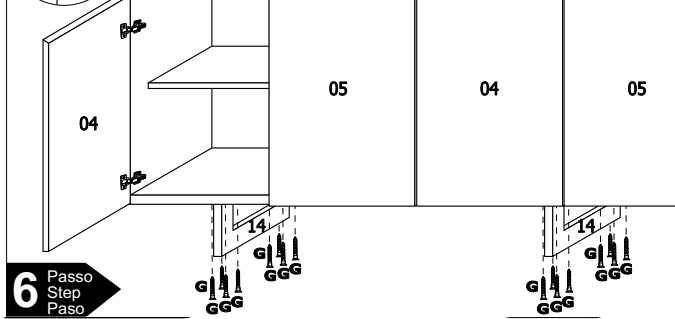

6 Passo
Step
Paso

5 Passo
Step
Paso

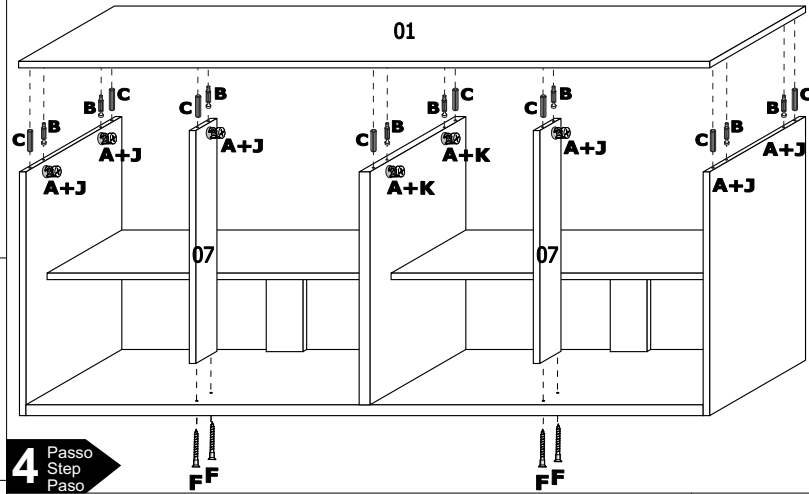
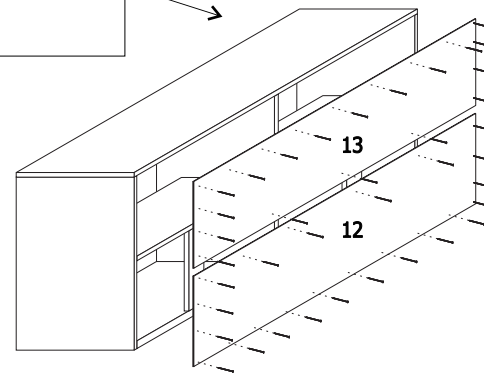

Ref.	Cód.: Fabrica	Descrição	Qtde
01	1202201	Tampo	01
02	1202202	Lateral Esquerda	01
03	1202203	Lateral Direita	01
04	1202204	Porta A1	02
05	1202205	Porta B2	02
06	1202206	Prateleira	02
07	1202207	Batente Frontal	02
08	1202208	Batente Traseiro	02
09	1202209	Base	01
10	1202210	Divisão	01
11	1202211	Trava	01
12	1202212	Fundo Inferior	01
13	1202213	Fundo Superior	01
14	120223	Pe Metal	02

