

ACESSÓRIOS REQUERIDOS

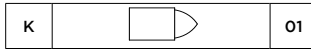

Pesos máximos recomendados com carga distribuída
 Peso máximo recomendado con la carga distribuida
 Recommended maximum weight with distributed load.

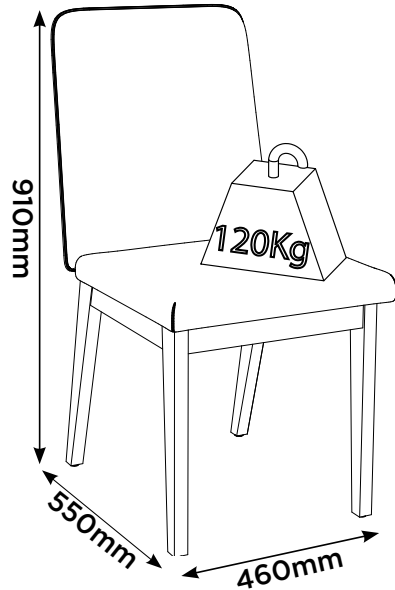

PERFECT CORRECTION
 CORRECCIÓN PERFECTA

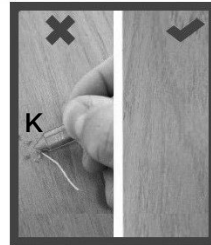

PRODUTO CONCLUÍDO
PRODUCTO TERMINADO
FINISHED PRODUCT

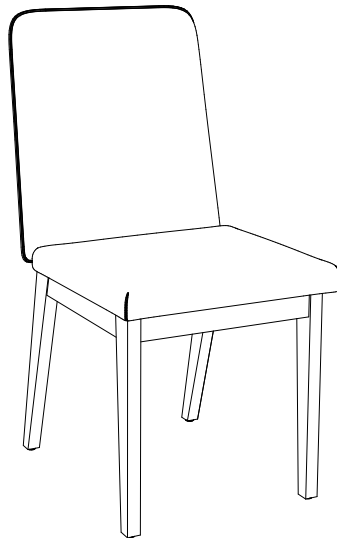

HENN

Ind. e Com. de Móveis Henn
 Mondai - SC - Brasil

+55 49 3674.3500

@moveishenn
 www.henn.com.br

INSTRUÇÕES DE MONTAGEM

INSTRUCCIONES DE MONTAJE
 ASSEMBLY INSTRUCTIONS

CADEIRA PIETRA | SILLA PIETRA | CHAIR PIETRA

S41-535 Nature/Corano Caramelo/Creme

S41-547 Nature/Corano Caramelo/Linho

S41-548 Nature/Corano Caramelo/Cacao

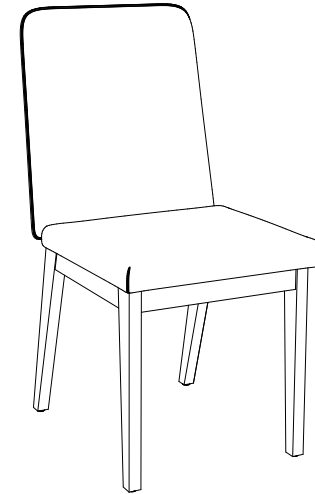

AVISO

Para limpeza de seu móvel, use uma flanela seca ou umedecida, e não utilize produtos químicos que possam danificar seu produto.

SISTEMA DE MONTAGEM

O sistema de montagem dos produtos, funciona de acordo com a ordem crescente dos números indicados no desenho. Ex: 01, 02, 03, 04... até a conclusão da montagem.

ASSISTÊNCIA TÉCNICA

Para solicitação de Assistência Técnica você consumidor deverá entrar em contato com o Lojista o qual você realizou a compra deste produto e solicitar a assistência técnica das peças avariadas. A garantia abrange todas as peças, partes e componentes que eventualmente venham apresentar defeito de fabricação no prazo de 03 (três) meses, contando a partir da entrega do produto ao consumidor, mediante nota fiscal de compra. Se houver qualquer alteração na estrutura do produto ou ocorrer defeito por negligência do montador/consumidor em relação a instrução de montagem e manuseio, não será fornecido assistência técnica gratuita.

ADVERTENCIA

Para limpieza de su móvil, use una franela seca o húmeda, y no utilice productos químicos que puedan dañar su producto.

SISTEMA DE MONTAJE

El sistema de montaje de los productos funciona de acuerdo con el orden creciente de los números indicados en el dibujo. Ej.: 01, 02, 03, 04... hasta la conclusión del montaje.

ASISTENCIA TÉCNICA

Para solicitar Asistencia Técnica, el consumidor debe comunicarse con el Comercio que usted realizó la compra de este producto y solicita asistencia técnica para las partes dañadas. La garantía cubre todas las partes, piezas y componentes que eventualmente puedan presentar defecto de fabricación en el plazo de 03 (tres) meses, contados a partir de la entrega del producto al consumidor, mediante factura de compra. Si se produce algún cambio en la estructura del producto o se produce un defecto por negligencia del montador/consumidor en relación con las instrucciones de montaje y manipulación, no se prestará asistencia técnica gratuita.

NOTICE

To clean your furniture, use a dry or wet cloth, and do not use chemicals that may damage your product.









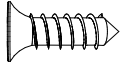

ASSEMBLY SYSTEM

The products' assembly system works according to the increasing order of the indicated numbers. For example: 01, 02, 03, 04 ... to the end of the assembly.

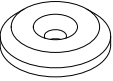
TECHNICAL ASSISTANCE

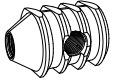
To request Technical Assistance, the consumer must contact the retailer from whom you purchased this product and request technical assistance for the damaged parts. The warranty covers all parts, parts and components that may eventually present a manufacturing defect within a period of 03 (three) months, counting from the delivery of the product to the consumer, by means of a purchase invoice. If there is any change in the structure of the product or defect occurs due to negligence of the assembler/consumer in relation to the assembly and handling instruction, free technical assistance will not be provided.

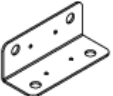

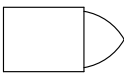
ACESSÓRIOS | ACCESORIOS | ACCESSORIES

A x56  Parafuso 4,0x14mm CHT.	B x8  Haste Roscada 1/4x60mm.	C x8  Haste Roscada 1/4x90mm.	D x8  Prego 12x12 Anelado.
E x8  Sapata Deslizadora 14x4x4mm.	F x16  Arruela Meia Lua 30x11mm.	G x8  Bucha Rosca 1/4x19mm.	H x16  Porca Sextavada para Boca 11mm.
I x12  Cantoneira 17,5x17x5x44mm	J x1  Chave de Boca Cementada.	K x1  Giz de Correção.	

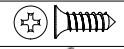
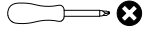

Parafusos em escala
Tornillos escalados **1:1**
Scaled screws

MONTAGEM 4 | MONTAJE 4 | ASSEMBLY 4

ACESSÓRIOS REQUERIDOS		FERRAMENTAS NECESSÁRIAS
A		48 
I		12



Posicione o Assento Estofado (8) de forma centralizada nas Travessas (3, 6 e 7) e fixe-o utilizando as Cantoneiras (I).

Coloque el asiento tapizado (8) de modo que centrado en los Travesaños (3, 6 y 7) y fijarlo usando los ángulos (I).

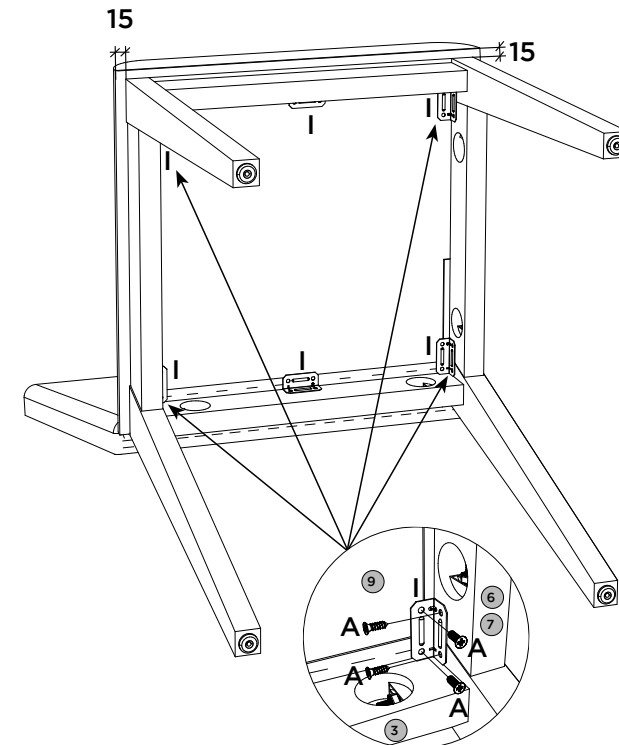
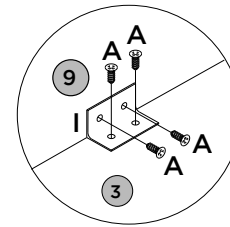

Position the Upholstered Seat (8) centrally on the Crossbars (3, 6 and 7) and secure it using the Corner Brackets (I).



PEÇAS REQUERIDAS

6	TRAVESSA LATERAL ESQUERDA	x2
7	TRAVESSA LATERAL DIREITA	x2

ACESSÓRIOS REQUERIDOS

F		08
H		08
J		01

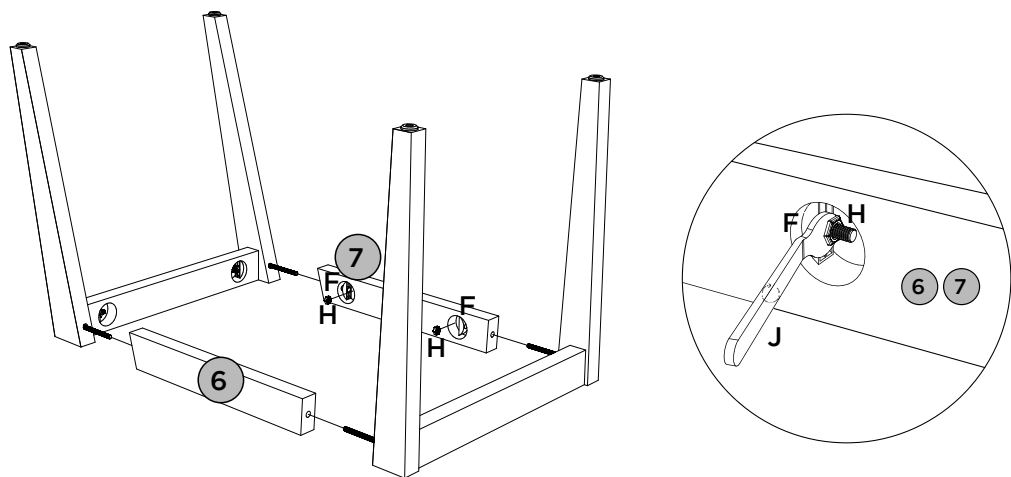

MONTAGEM 3 | MONTAJE 3 | ASSEMBLY 3

PEÇAS REQUERIDAS

8	ENCOSTO ESTOFADO	x2
9	ASSENTO ESTOFADO	x2

ACESSÓRIOS REQUERIDOS

A		08
---	--	----

FERRAMENTAS NECESSÁRIAS

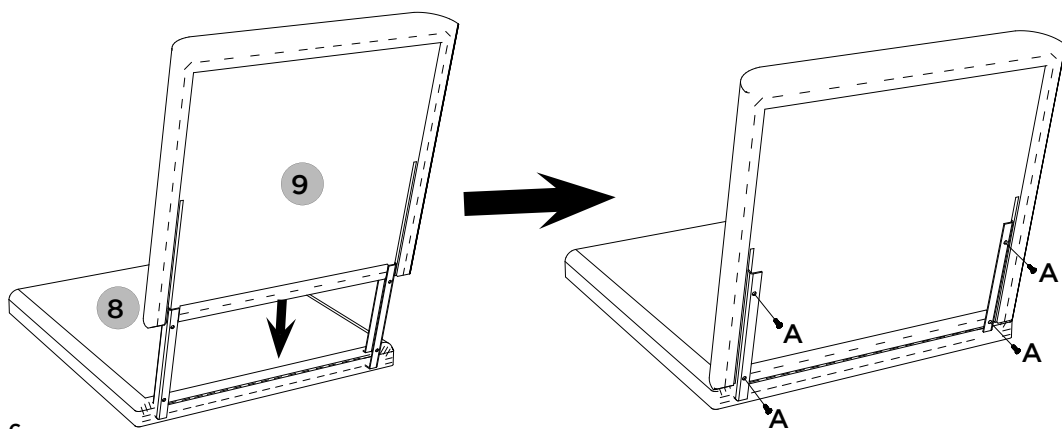
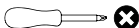

LISTA DE PEÇAS | LISTA DE PIEZAS | LIST OF PIECES

Item	Caixa Caja Box	Qtd Ctd Qty	Descrição Descripción Description	Dimensões (mm) Dimensiones (mm) Dimensions (mm)		
				Comprimento Largo Length	Largura Ancho Width	Espessura Grosor Thickness
1	1/1	2	PÉ FRONTAL ESQUERDO PIE DELANTERO IZQUIERDO FRONT FOOT LEFT	425	50	27
2	1/1	2	PÉ FRONTAL DIREITO PIE DELANTERO DERECHO FRONT FOOT RIGHT	425	50	27
3	1/1	4	TRAVESSA FRONTAL TRASEIRA PLATO DELANTERO TRASERO FRONT PLATTER	370	50	25
4	1/1	2	PÉ TRASEIRO ESQUERDO PIE TRASERO IZQUIERDO HIND FOOT LETF	425	152	27
5	1/1	2	PÉ TRASEIRO DIREITO PIE TRASERO DERECHO HIND FOOT RIGHT	425	152	27
6	1/1	2	TRAVESSA LATERAL ESQUERDA PLATO LATERAL IZQUIERDO SIDE PLATTER LEFT	330	50	25
7	1/1	2	TRAVESSA LATERAL DIREITA PLATO LATERAL DERECHO SIDE PLATTER RIGHT	330	50	25
8	1/1	2	ENCOSTO ESTOFADO RESPALDO TAPIZADO UPHOLSTERED BACKREST	500	430	60
9	1/1	2	ASSENTO ESTOFADO ASIENTO TAPIZADO UPHOLSTERED SEAT	460	440	65

VISTA EXPLODIDA DAS PEÇAS | VISTA DESPIECE DE LAS PIEZAS | EXPLODED VIEW OF THE PARTS.

O volume contém peças para montagem de 2 Cadeiras.

El volumen contiene piezas para montar 2 sillas.

The volume contains parts for mounting 2 Chairs.

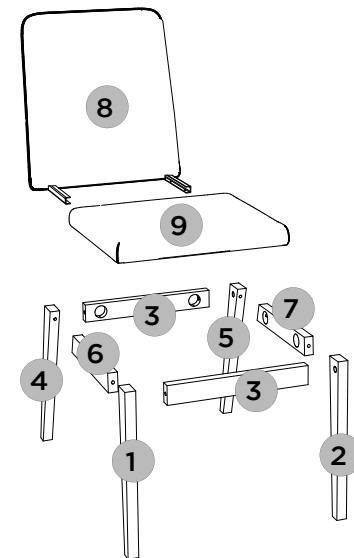

REQUISITOS PARA MONTAGEM | REQUISITOS PARA LA MONTAJE | ASSEMBLY REQUIREMENTS.

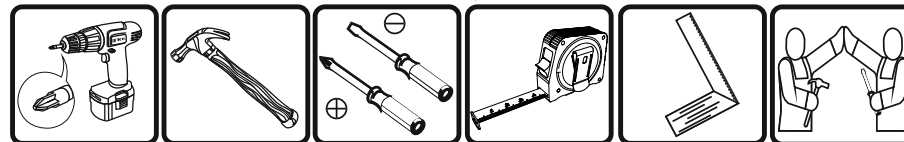





Imagens meramente ilustrativas, não acompanha o produto.
 Imágenes ilustrativas, no incluidas con el producto.
 Illustrative images, not included with the product.

PEÇAS REQUERIDAS

1	PÉ FRONTAL ESQUERDO	x2
2	PÉ FRONTAL DIREITO	x2
4	PÉ TRASEIRO ESQUERDO	x2
5	PÉ TRASEIRO DIREITO	x2

ACESSÓRIOS REQUERIDOS

B		08
C		08
D		08
E		08
G		08

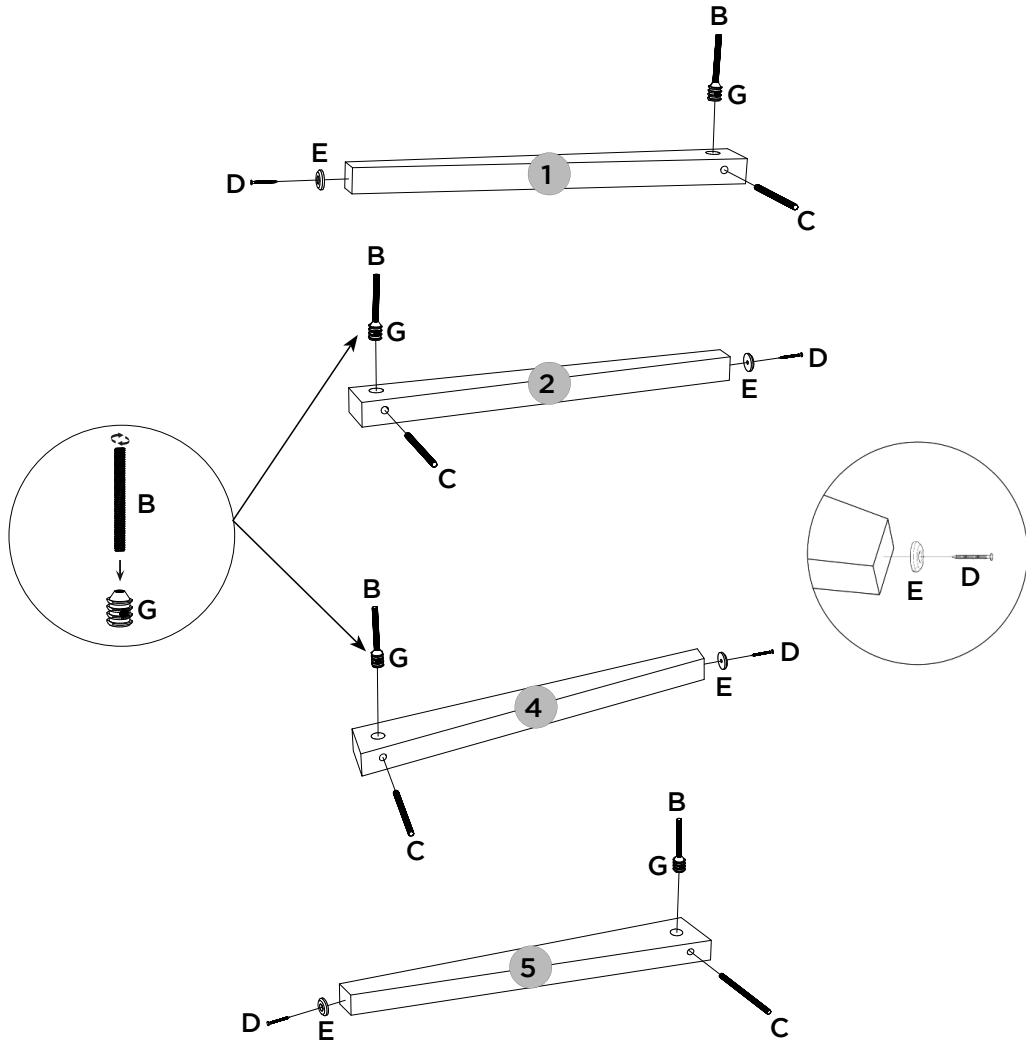
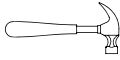

FERRAMENTAS NECESSÁRIAS



PEÇAS REQUERIDAS

1	PÉ FRONTAL ESQUERDO	x2
2	PÉ FRONTAL DIREITO	x2
3	TRAVESSA FRONTAL TRASEIRA	x4
4	PÉ TRASEIRO ESQUERDO	x2
5	PÉ TRASEIRO DIREITO	x2

ACESSÓRIOS REQUERIDOS

F		08
H		08
J		01

