

Modelo: **KF 3081 DT ZAGREB6**

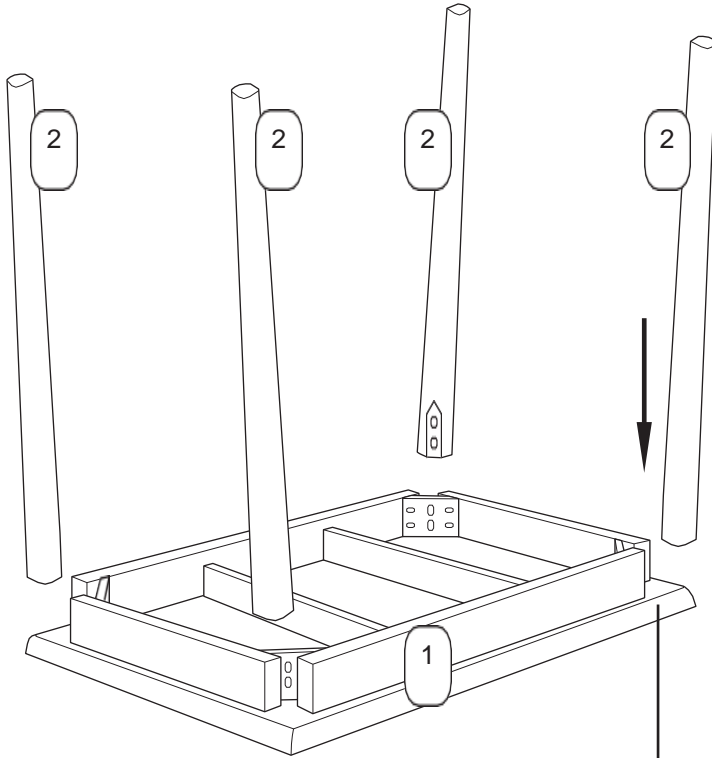

## INSTRUCCIONES DE ARMADO



| No | Lista de Partes | Qty.  |
|----|-----------------|-------|
| 1  | Cubierta        | 1 pc  |
| 2  | Patas mesa      | 4 pcs |

| No | Lista de Herrajes  | Qty.  |
|----|--|-------|
| A  | tornillo JCBC       | 8 pcs |
| B  | Golilla espiral M8  | 8 pcs |
| C  | Golilla Plana M8    | 8 pcs |
| D  | Llave Allen M5      | 1 pc  |

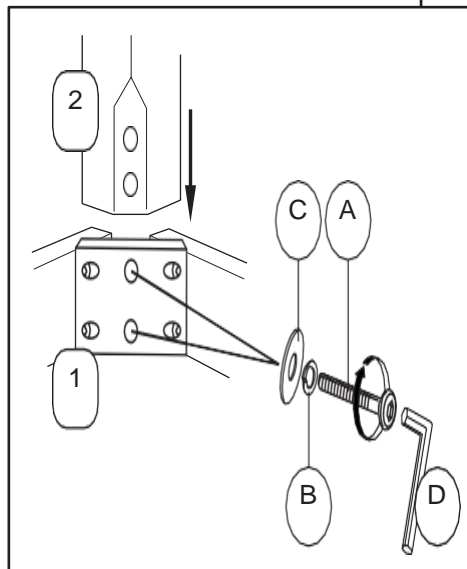





### Importante:

- Coloque las piezas de madera sobre una superficie limpia y plana, como una alfombra para evitar que las piezas se rayen.
- Siga las instrucciones de Armado paso a paso. (Como se indica en los diagramas).
- No Apriete todos los tornillos hasta que la mesa esté armada completamente. (hágalo al final cuando tenga todo en su lugar).
- Identifique de manera correcta cada componente de armado para evitar daños a la cubierta.

ASSEMBLY INSTRUCTION

MODEL: **KF 4241 DC**

Important note: - Place all wooden part on a clean and smooth surface such as rug or carpet to avoid the part from being scratch.  
 - Please follow the assembly instruction step by step.  
 - Do not tighten all screw until the chair is fully set-up.

| No | Hardware List  | QTY.   |
|----|--|--------|
| A  | JCBC M6 x 70mm    | 16 pcs |
| B  | M6 Spring Washer  | 16 pcs |
| C  | M6 Flat Washer    | 16 pcs |
| D  | CSK M4 x 32mm     | 8 pcs  |
| E  | M4 Allen Key      | 1 pc   |



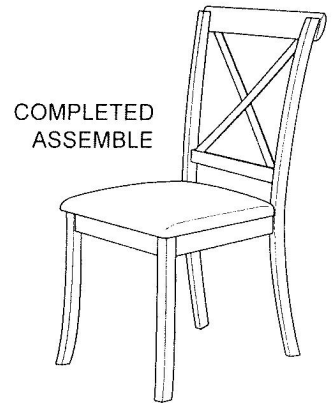
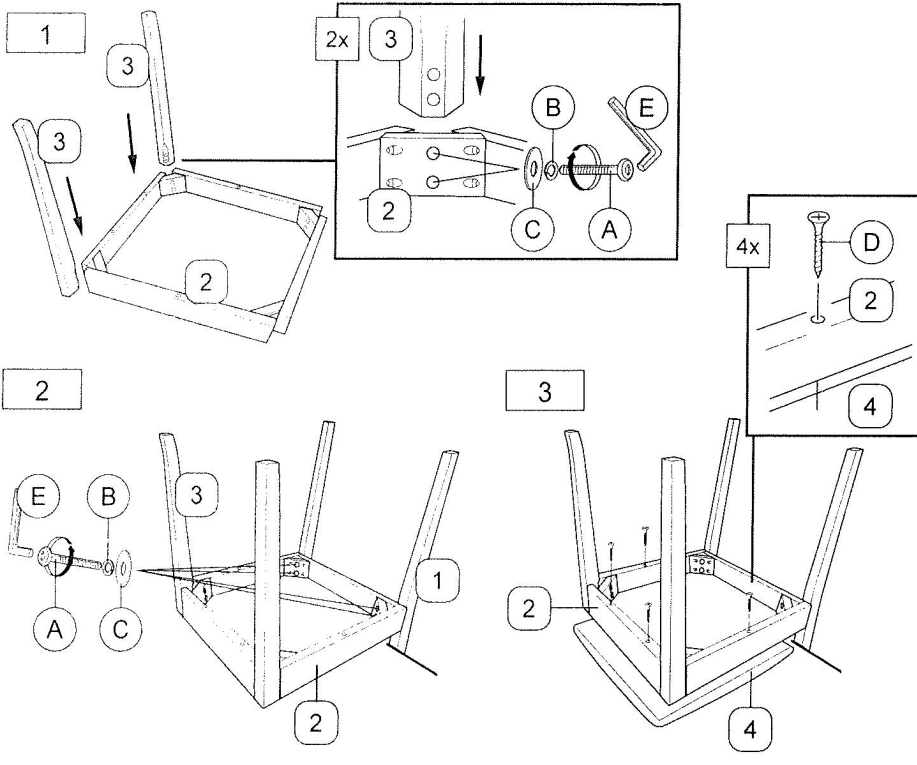

| No | Part List             | QTY.  |
|----|-----------------------|-------|
| 1  | Backrest              | 2 pcs |
| 2  | Box Seat              | 2 pcs |
| 3  | Front Leg             | 4 pcs |
| 4  | Wooden Slat / Cushion | 2 pcs |



ASSEMBLY INSTRUCTION

MODEL: **KF 4241 DC**

Important note: - Place all wooden part on a clean and smooth surface such as rug or carpet to avoid the part from being scratch.  
 - Please follow the assembly instruction step by step.  
 - Do not tighten all screw until the chair is fully set-up.

| No | Hardware List  | QTY.   |
|----|--|--------|
| A  | JCBC M6 x 70mm    | 16 pcs |
| B  | M6 Spring Washer  | 16 pcs |
| C  | M6 Flat Washer    | 16 pcs |
| D  | CSK M4 x 32mm     | 8 pcs  |
| E  | M4 Allen Key      | 1 pc   |

| No | Part List             | QTY.  |
|----|-----------------------|-------|
| 1  | Backrest              | 2 pcs |
| 2  | Box Seat              | 2 pcs |
| 3  | Front Leg             | 4 pcs |
| 4  | Wooden Slat / Cushion | 2 pcs |

