

Modelo: **KF 3081 DT ZAGREB4**

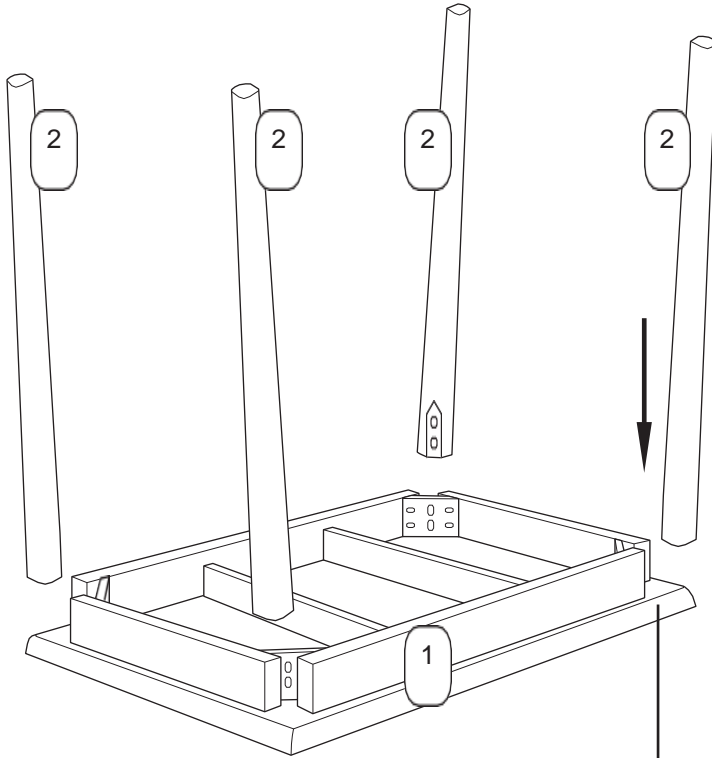

INSTRUCCIONES DE ARMADO



No	Lista de Partes	Qty.
1	Cubierta	1 pc
2	Patatas mesa	4 pcs

No	Lista de Herrajes	Qty.
A	tornillo JCBC 	8 pcs
B	Golilla espiral M8 	8 pcs
C	Golilla Plana M8 	8 pcs
D	Llave Allen M5 	1 pc

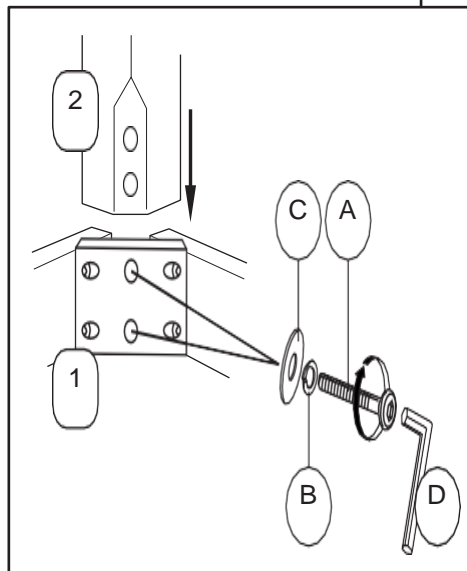





Importante:

- Coloque las piezas de madera sobre una superficie limpia y plana, como una alfombra para evitar que las piezas se rayen.
- Siga las instrucciones de Armado paso a paso. (Como se indica en los diagramas).
- No Apriete todos los tornillos hasta que la mesa esté armada completamente. (hágalo al final cuando tenga todo en su lugar).
- Identifique de manera correcta cada componente de armado para evitar daños a la cubierta.

ASSEMBLY INSTRUCTION

MODEL: **KF 4241 DC**

Important note: - Place all wooden part on a clean and smooth surface such as rug or carpet to avoid the part from being scratch.
 - Please follow the assembly instruction step by step.
 - Do not tighten all screw until the chair is fully set-up.

No	Hardware List	QTY.
A	JCBC M6 x 70mm 	16 pcs
B	M6 Spring Washer 	16 pcs
C	M6 Flat Washer 	16 pcs
D	CSK M4 x 32mm 	8 pcs
E	M4 Allen Key 	1 pc



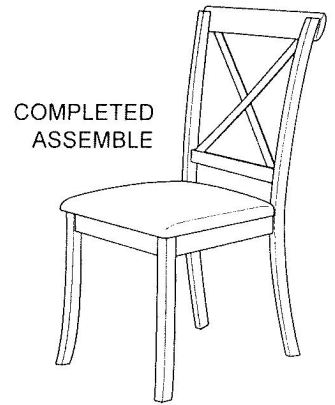
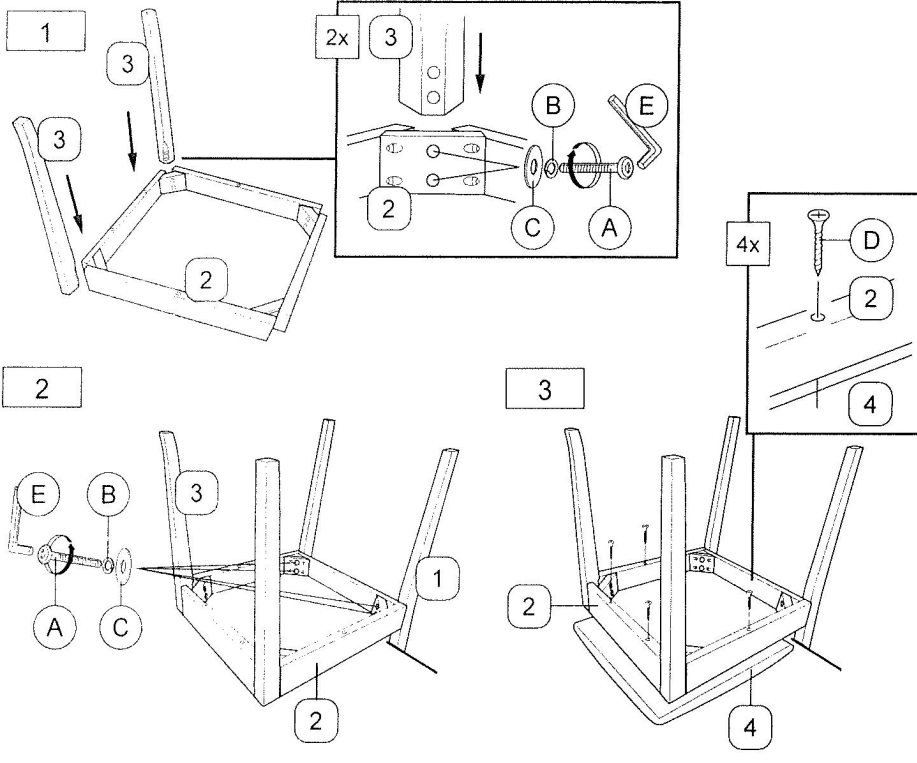

No	Part List	QTY.
1	Backrest	2 pcs
2	Box Seat	2 pcs
3	Front Leg	4 pcs
4	Wooden Slat / Cushion	2 pcs



ASSEMBLY INSTRUCTION

MODEL: **KF 4241 DC**

Important note: - Place all wooden part on a clean and smooth surface such as rug or carpet to avoid the part from being scratch.
 - Please follow the assembly instruction step by step.
 - Do not tighten all screw until the chair is fully set-up.

No	Hardware List	QTY.
A	JCBC M6 x 70mm 	16 pcs
B	M6 Spring Washer 	16 pcs
C	M6 Flat Washer 	16 pcs
D	CSK M4 x 32mm 	8 pcs
E	M4 Allen Key 	1 pc

No	Part List	QTY.
1	Backrest	2 pcs
2	Box Seat	2 pcs
3	Front Leg	4 pcs
4	Wooden Slat / Cushion	2 pcs

